



IEC Contactor Specifications

Bulletin Numbers 100/104-K, 100/104-C, 100/104S-C, 100/104-E, 100S-E



Topic	Page
Summary of Changes	2
Product Line Overview	3
IEC Contactors	3
Safety Contactors	4
100-K/104-K Miniature Contactors	5
Product Selection	5
Accessories	8
Specifications	11
Life-Load Curves	15
Approximate Dimensions	16
100-C/104-C, 100S-C/104S-C Contactors	17
Product Selection—100-C/104-C Contactors	17
Product Selection—100S-C/104S-C Safety Contactors	23
Accessories	31
Renewal Parts	36
Specifications	38
Life-Load Curves	49
Approximate Dimensions	56
100-E/104-E, 100S-E/104S-E Contactors	58
Product Selection—100-E/104-E Contactors	58
Product Selection—100S-E Safety Contactors	61
Assignment of Contacts	65
Renewal Parts	76
Specifications	78
Life-Load Curves	98
Approximate Dimensions	105
Additional Resources	121

Summary of Changes



This publication contains the following new or updated information. This list includes substantive updates only and is not intended to reflect all changes.

Topic	Page
Added tables for Device Combinations in Accordance with IEC 60947-1 / -4-1, update tables and add new figures for safety and safety reversing contactors	Throughout

IEC Contactors

			
Bulletin No.	100-K/104-K	100-C/104-C	100-E/104-E
Screw Terminals	✓	✓	✓ (9...96 A), Thru-hole (116...2650 A)
Spring Terminals	✓ (5...9 A)	✓ (9...16 A)	–
Max. Current I_e	12 A	97 A	2650 A
Current Rating	5...12 A	9...97 A	9...2650 A
Features	<ul style="list-style-type: none"> • Mini contactors • Uniform panel mounting dimensions • Panel mounting or mounting on 35 mm DIN Rail • AC or DC coil control • Made of environmentally friendly materials 	<ul style="list-style-type: none"> • Panel mounting or mounting on 35 mm DIN Rail • AC or DC coil control • Reversible coil terminals (line or load side) • Common accessories • Made of environmentally friendly materials 	<ul style="list-style-type: none"> • Panel mounting or mounting on 35 mm DIN Rail • E09...E370 <ul style="list-style-type: none"> – AC/DC electronic coil with built-in surge suppression – optional PLC interface on E116...E370 • E400...E2650 <ul style="list-style-type: none"> – AC/DC electronic coil with built-in surge suppression and PLC interface • Made of environmentally friendly materials
Contacts	<ul style="list-style-type: none"> • 3 power poles with internal N.O. or N.C. auxiliary contact, or 4 power poles. • Optional front-mounted 2- or 4-pole external auxiliary contact block. 	<ul style="list-style-type: none"> • 3 power poles with internal N.O. or N.C. auxiliary contact or 4 power poles (9...23 A). • Optional front- or side-mounted 1-, 2- or 4-pole external auxiliary contact block. 	<ul style="list-style-type: none"> • 3 main poles with 2 auxiliary contacts (1 N.O. and 1 N.C.) on E116...E2650 • Optional side- or front-mounted external auxiliary contact block.
Coil Voltages	24...600V AC, 50/60Hz 12...250V DC	12...480V AC, 50/60Hz 9...250V DC	20...500V, 50/60 Hz/DC
Optional Overload Relays	Electronic or bimetallic	Electronic or bimetallic	Electronic
Optional Accessories	<ul style="list-style-type: none"> • Front-mount auxiliary contacts • Surge suppressors • Electronic timers • Mechanical interlocks 	<ul style="list-style-type: none"> • Front or side-mount auxiliary contacts • Surge suppressors • Electronic or pneumatic timers • Mechanical interlocks • Mechanical latches 	<ul style="list-style-type: none"> • Side- or front-mount auxiliary contacts • Mechanical interlocks • Terminal lugs • Terminal shields • Connecting bars • Electronic timers (9...96 A) • Mechanical latches (9...96 A)
Standards/Certifications	<ul style="list-style-type: none"> • UL • CSA • IEC • CE Marked • CCC 	<ul style="list-style-type: none"> • UL • CSA • IEC • CE Marked • CCC 	<ul style="list-style-type: none"> • EN/IEC • CE Marked • cULus • CCC • EAC • C-tick • KC

Safety Contactors

		
Bulletin No.	100S-C/104S-C	100S-E/104S-E
Screw Terminals	3	Thru-hole
Max. Current I_e	97 A	750 A
Current Rating	9...97 A	9...750 A
Features	<ul style="list-style-type: none"> • Positively guided/mechanically linked auxiliary contacts • Front-mounted auxiliary contacts: <ul style="list-style-type: none"> - Permanently fixed - Protective cover to prevent manual operation - Red contact housing for easy identification - Incorporates IEC 947-5-1 "Mechanically Linked" symbol - Optional gold-plated bifurcated versions • AC and DC operating coils • SUVA third-party certification 	<ul style="list-style-type: none"> • Mirror contact performance on auxiliary contacts • Red N.C. low-power auxiliary contacts used for feedback circuit • SUVA third-party certification • AC/ DC operating coils with built-in surge suppression • "Mirror Contact" symbol on front
Contacts	3 main poles with N.C. mechanically linked or mirror feedback contacts	3 main poles with N.C. mirror feedback contacts
Coil Voltages	12...480V AC, 50/60Hz 12...250V DC	20...500V, 50/60 Hz/DC
Optional Overload Relays	Electronic or bimetallic	Electronic
Optional Accessories	<ul style="list-style-type: none"> • Side-mount auxiliary contacts • Surge suppressors • Electronic timers • Mechanical interlocks 	<ul style="list-style-type: none"> • Side-mount auxiliary contacts • Electronic timers (9...96 A) • Mechanical interlocks (9...96 A) • Terminal shields • Terminal lugs • Terminal enlargements • Terminal extensions • Connection bars for 140G molded case circuit breakers, 140MG motor protection circuit breakers, and 140MG motor circuit protectors
Standards Compliance	<ul style="list-style-type: none"> • EN/IEC 60947-4 • IEC 60947-5-1, Annex L – Mechanically Linked Contacts • IEC 60947-4-1, Annex F – Mirror Contacts • UL 508 • CSA C22.2 No. 14 • EN50205 	<ul style="list-style-type: none"> • EN/IEC 60947-4-1 • IEC 60947-5-1, Annex L – Mechanically Linked Contacts • IEC 60947-4-1, Annex F – Mirror Contacts • UL 60947-4-1 • CSA C22.2, No. 60947-4-1
Certifications	<ul style="list-style-type: none"> • cULus Listed (File No. E3125; Guide NLDX, NLDX7) • SUVA Third-Party Certified • CE Marked 	<ul style="list-style-type: none"> • cULus Listed (File No. E41850; Guide No. NLDX, NLDX7) • CE Marked • CCC • UL • CSA • EAC • RCM (C-tick) • SUVA Third-Party Certified • KC

Product Selection

- 3-Pole AC- and DC-operated contactors
- Compact size
- Same dimensions for AC and DC
- Full-voltage non-reversing and reversing contactors
- 5, 9, and 12 A contactors rated at 690V
- IP2X finger protection
- Optional integrated surge suppressor
- Compatible with Bulletin 193-K bimetallic overload relay
- Mirror contacts per IEC 60947-4-1 and mechanically linked contacts per IEC 60947-5-1 on main unit



100-K Miniature Contactor



104-K Reversing Miniature Contactor

Bulletin 100-K miniature contactors are designed for commercial and light industrial applications where panel space is at a premium. These miniature devices, while 45 mm wide, are shallower and have less panel depth requirements than standard IEC contactors.

The miniature contactors have been designed with flexibility in mind. They are available with AC or DC operating coils, several contact ratings, and optional 2- or 4-pole adder decks in a variety of auxiliary contact configurations.



3-Pole AC- and DC-operated Contactors

Rated Operational Current I_e [A]		Ratings for switching AC motors - AC-2, AC-3, AC-4										Auxiliary Contacts		Pkg. Qty. ⁽¹⁾	Cat. No.
		3-phase kW (50 Hz)				Hp (60 Hz)						N.O.	N.C.		
40 °C (104 °F)		230V	400/415V	500V	690V	1-Phase		3-Phase							
AC-3	AC-1					115V	230V	200V	230V	460V	575V				
Screw Terminals															
5	20	1.5	2.2	2.2	2.2	1/2	1	1-1/2	1-1/2	3	3	1	0	1	100-K05⊗10
												0	1		
9	20	3	4	4	4	1/2	1-1/2	2	2	5	5	1	0	1	100-K09⊗10
												0	1		
12	20	3	5.5	5.5	5.5	3/4	2	3	3	7-1/2	7-1/2	1	0	1	100-K12⊗10
												0	1		
Spring Clamp Terminals															
5	10	1.5	2.2	2.2	2.2	1/3	3/4	1-1/2	1-1/2	3	3	1	0	1	100-KR05⊗10
												0	1		
9	10	2.2	4	4	4	1/3	1	2	2	5	5	1	0	1	100-KR09⊗10
												0	1		

(1) May be ordered in package quantities of 20. Add letter M to the end of the cat. no. Example: **100-K09ZJ10M**.



⊗ Coil voltage code — see [page 6](#).

4-Pole AC- and DC-operated Contactors

Rated Operational Current I_e [A]		Ratings for switching AC motors - AC-2, AC-3										Contact Configuration, Main Poles		Pkg. Qty. ⁽¹⁾	Cat. No.
		3-phase kW (50 Hz)				Hp (60 Hz)									
		40 °C (104 °F)		230V	400/415V	500V	690V	1-Phase		3-Phase					
AC-3	AC-1	115V	230V					200V	230V	460V	575V	N.O.	N.C.		
5	20	1.5	2.2	2.2	2.2	1/2	1	1-1/2	1-1/2	3	3	4	0	1	100-K05⊗400
												3	1	1	100-K05⊗300
												2	2	1	100-K05⊗200
9	20	3	4	4	4	1/2	1-1/2	2	2	5	5	4	0	1	100-K09⊗400
												3	1	1	100-K09⊗300
												2	2	1	100-K09⊗200
12	20	3	5.5	5.5	5.5	3/4	2	3	3	7-1/2	7-1/2	4	0	1	100-K12⊗400
												3	1	1	100-K12⊗300
												2	2	1	100-K12⊗200

(1) May be ordered in package quantities of 20. Add letter M to the end of the cat. no. Example: 100-K09ZJ400M.

Reversing AC- and DC-operated Contactors

Rated Operational Current I_e [A]		Ratings for switching AC motors - AC-2, AC-3, AC-4										Auxiliary Contacts per Contactor ⁽¹⁾		Cat. No. ⁽²⁾
		3-phase kW (50 Hz)				Hp (60 Hz)								
		40 °C (104 °F)		230V	400/415V	500V	690V	1-Phase		3-Phase				
AC-3	AC-1	115V	230V					200V	230V	460V	575V	N.O.	N.C.	
5	20	1.5	2.2	2.2	2.2	—	—	1-1/2	1-1/2	3	3	0	1	104-K05⊗02
9	20	3	4	4	4	—	—	2	2	5	5	0	1	104-K09⊗02
12	20	3	5.5	5.5	5.5	—	—	3	3	7-1/2	7-1/2	0	1	104-K12⊗02

(1) Used for electrical interlocking.

(2) Bulletin 104-K reversing contactors are factory assembled and include contactors, mechanical interlock (Cat. No. 100-KMCH) and wiring kit (Cat. No. 100-KPR) for power and control circuit (electrical interlock).

Coil Voltage Codes

The Cat. No. as listed is incomplete. Select a coil voltage code from the table below to complete the Cat. No.
 Example: 120V, 60 Hz: Cat. No. 100-K09⊗10 becomes Cat. No.100-K09D10.

Screw type terminal versions

AC Voltages [V]	24	110	120	230	240	400	480	600	DC Voltages [V]	12	24	110	125	220	250
50 Hz	—	D	—	—	—	—	—	—	Standard	ZQ	ZJ	ZD	ZS	ZA	ZT
60 Hz	—	—	D	—	—	—	B	VC	with Integrated Diode	—	DJ	—	—	—	—
50/60 Hz	KJ	—	—	KF	KA	KN	—	—							

Spring clamp type terminal versions

AC Voltages [V]	24	110	120	230	DC Voltages [V]	24	110
50 Hz	—	D	—	—	Standard	ZJ	ZD
60 Hz	—	—	D	—	with Integrated Diode	DJ	—
50/60 Hz	KJ	—	—	KF			

Assignment of Contacts

Table valid for: AC / DC = 0.85...1.1 x U_S, T_{amb} = -25 °C...+60 °C (-13...140 °F), normal position (horizontal rail mounting)

Device Combinations in Accordance with IEC 60947-1 / -4-1

Auxiliary Contact Blocks ⁽¹⁾		100-K Miniature Contactors (AC and DC Control)					
Circuit Diagram	Control	100-K05⊗10 100-K09⊗10 100-K12⊗10	100-K05⊗01 100-K09⊗01 100-K12⊗01	100-K05⊗400 100-K09⊗400 100-K12⊗400	100-K05⊗300 100-K09⊗300 100-K12⊗300	100-K05⊗200 100-K09⊗200 100-K12⊗200	
100-KFA02E	AC/DC	(2)	01 + 02 = 03 ⁽³⁾	(2)	(2)(3)	—	
100-KFC02	AC/DC	10 + 02 = 12	—	00 + 02 = 02	00 + 02 = 02 ⁽³⁾	—	
100-KFA11E	AC/DC	(2)	01 + 11 = 12	(2)	(2)	(2)	
100-KFB11	AC/DC	10 + 11 = 21	—	00 + 11 = 11	00 + 11 = 11	00 + 11 = 11	
100-KFC11	AC/DC	10 + 11 = 21	(2)	00 + 11 = 11	00 + 11 = 11	00 + 11 = 11	
100-KFA20E	AC/DC	(2)	01 + 20 = 21	(2)	(2)	(2)	
100-KFC20	AC/DC	10 + 20 = 30	(2)	00 + 20 = 20	00 + 20 = 20	00 + 20 = 20	
100-KFA04E	AC/DC	(2)(3)	—	(2)(3)	—	—	
100-KFC04	AC/DC	10 + 04 = 14 ⁽³⁾	—	00 + 04 = 04 ⁽³⁾	—	—	
100-KFA13E	AC/DC	(2)	01 + 13 = 14 ⁽³⁾	(2)	(2)(3)	—	
100-KFC13	AC/DC	10 + 13 = 23	(2)(3)	00 + 13 = 13	00 + 13 = 13 ⁽³⁾	—	
100-KFA22Z	AC/DC	(2)	01 + 22 = 23 ⁽³⁾	(2)	(2)(3)	—	
100-KFB22	AC/DC	10 + 22 = 32	—	00 + 22 = 22	00 + 22 = 22 ⁽³⁾	—	
100-KFC22	AC/DC	10 + 22 = 32	(2)(3)	00 + 22 = 22	00 + 22 = 22 ⁽³⁾	—	
100-KFA31Z	AC/DC	(2)	—	(2)(4)	—	—	

Device Combinations in Accordance with IEC 60947-1 / -4-1 (Continued)

Auxiliary Contact Blocks ⁽¹⁾		100-K Miniature Contactors (AC and DC Control)				
Circuit Diagram	Control	100-K05⊗10 100-K09⊗10 100-K12⊗10	100-K05⊗01 100-K09⊗01 100-K12⊗01	100-K05⊗400 100-K09⊗400 100-K12⊗400	100-K05⊗300 100-K09⊗300 100-K12⊗300	100-K05⊗200 100-K09⊗200 100-K12⊗200
100-KFC31	AC/DC	10 + 31 = 41 ⁽⁴⁾	—	00 + 31 = 31 ⁽⁴⁾	—	—
100-KFA40E	AC/DC	(2)	(2)	(2)	(2)	(2)
100-KFC40	AC/DC	10 + 40 = 50	(2)	00 + 40 = 40	00 + 40 = 40	00 + 40 = 40











- (1) For other operating limits, please contact your local Rockwell Automation sales office or Allen-Bradley distributor.
- (2) Combination possible but not recommended, due to repeating or not consecutive sequence numbering.
- (3) T_{amb} max. +40 °C (104 °F).
- (4) T_{amb} max. +40 °C (104 °F) and only allowed for coil voltage 24V DC or 230V AC.

Accessories



Auxiliary Contact Blocks

Description	Connection Diagrams			For Use With	Pkg. Qty.	Cat. No.	
		N.O.	N.C.			Screw Type Terminals	Spring Clamp Terminals
Front-mounted Auxiliary Contacts <ul style="list-style-type: none"> Auxiliary contact blocks 2- and 4-pole versions Choice of contact configurations Snap on, no tools required Electronic-compatible bifurcated contacts for signals down to 15V/2 mA Mirror Contact performance per IEC 60947-4-1 		0	2	100-K05...K12	1	100-KFC02	100-KRFC02
		1	1	100-K05...K12	1	100-KFC11	100-KRFC11
		2	0	100-K05...K12	1	100-KFC20	100-KRFC20
		0	4	100-K05...K12	1	100-KFC04	100-KRFC04
		1	3	100-K05...K12	1	100-KFC13	100-KRFC13
		3	1	100-K05...K12	1	100-KFC31	100-KRFC31
		2	2	100-K05...K12	1	100-KFC22	100-KRFC22
		4	0	100-K05...K12	1	100-KFC40	100-KRFC40

Auxiliary Contact Blocks (Continued)

	Description	Connection Diagrams	N.O. / N.C.		For Use With	Pkg. Qty.	Cat. No.	
			N.O.	N.C.			Screw Type Terminals	Spring Clamp Terminals
	Front-mounted Auxiliary Contacts • Auxiliary contact blocks 2- and 4-pole versions • Choice of contact configurations • Snap on, no tools required • Electronic-compatible bifurcated contacts for signals down to 15V/2 mA • Mirror Contact performance per IEC 60947-4-1		0	2	100/104-K, 700-K	1	100-KFA02E	100-KRFA02E
			1	1	100/104-K, 700-K	1	100-KFA11E	100-KRFA11E
			2	0	100/104-K, 700-K	1	100-KFA20E	100-KRFA20E
	Front-mounted Auxiliary Contacts • Auxiliary contact blocks 2- and 4-pole versions • Choice of contact configurations • Snap on, no tools required • Electronic-compatible bifurcated contacts for signals down to 15V/2 mA • Mirror Contact performance per IEC 60947-4-1		0	4	100/104-K, 700-K	1	100-KFA04E	100-KRFA04E
			1	3	100/104-K, 700-K	1	100-KFA13E	100-KRFA13E
			2	2	100/104-K, 700-K	1	100-KFA22Z	100-KRFA22Z
			3	1	100/104-K, 700-K	1	100-KFA31Z	100-KRFA31Z
			4	0	100/104-K, 700-K	1	100-KFA40E	100-KRFA40E

Control Modules

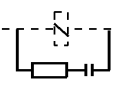
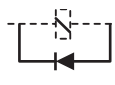
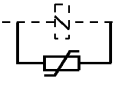

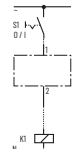

	Description	Connection Diagrams	For Use With	Pkg. Qty.	Cat. No.
	Mechanical Interlock • For interlocking of two adjacent contactors No added width to contactor assembly • Front mount plug-in type • Optional auxiliary contact blocks and suppressor modules mount onto the interlock		100/104-K/-KR, 700-K/-KR	1	100-KMCH
	Surge Suppressor • Plug-in type • Limits surge voltage on coil drop-off		100/104-K/-KR, 700-K/-KR	1 ⁽¹⁾	100-KFSC50
				1 ⁽¹⁾	100-KFSC280
				1 ⁽¹⁾	100-KFSC480
			100/104-K/-KR, 700-K/-KR	1 ⁽¹⁾	100-KFSV55
				1 ⁽¹⁾	100-KFSV136
				1 ⁽¹⁾	100-KFSV277
	100/104-K/-KR, 700-K/-KR	1 ⁽¹⁾	100-KFSD250		

(1) May be ordered in package quantities of 10. Add letter M to the end of the cat. no. Example: 100-KFSC50M.

Timers

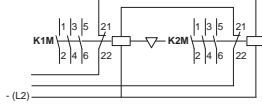

	Description	Connection Diagrams	For Use With	Pkg. Qty.	Cat. No.
	Solid-State Timing Element • 110...250V AC or DC • Includes 35 mm Hat Rail adapter		100/104-K, 700-K	10	100-KT3S 100-KT30S

Connecting Components

	Description	For Use With	Pkg. Qty.	Cat. No.	
	ECO Connecting Module – 12 A <ul style="list-style-type: none"> For DOL and reversing starters Eco-starters mount on single DIN Rail (140M on DIN Rail) Electrical and mechanical interconnection of 140M and 100-K contactors 	Connects: 140M-C circuit breakers with 100-K contactors	140M-C to 100-K	1 ⁽¹⁾	140M-C-PEK12
	Power Wiring Kit <ul style="list-style-type: none"> For Reversing and Star/Delta combinations. Star-point bridge not included. Min. interruption time 50 ms 		100-K	1	100-KPR
	Feeder Terminal for Compact Bus Bars <ul style="list-style-type: none"> Max. current 34 A 	Supply of compact bus bars	100-K	1	100-KWT
	Three-phase Compact Bus Bars <ul style="list-style-type: none"> Max. current 34 A For 100-K, 5...12 A contactors 	45 mm spacing (3 connections) ⁽²⁾	100-K, 5...12 A	1	100-KW453
		45 mm spacing (4 connections) ⁽²⁾	100-K, 5...12 A	1	100-KW454

(1) May be ordered in package quantities of 10. Add letter M to the end of the cat. no. Example: 140M-C-PEK12M.
 (2) Combinations possible. Example: For 6 contactor connections use one cat. no. 100-KW453 and one cat. no. 100-KW454.

Marking Systems

	Description	Pkg. Qty.	Cat. No.	
	Label Sheet <ul style="list-style-type: none"> 105 self-adhesive paper labels each, 6 x 17 mm (0.236 x 0.67 in) 	10	100-FMS	
	Adhesive labels <ul style="list-style-type: none"> Each label 6 x 17 mm (0.236 x 0.67 in) White, halogen-free polyester, with acrylate adhesive Ambient temperature range -40...+120 °C (-40...+248 °F) Qty: 3000/roll 	Ribbon: Cat. No. 1492-PRILAB Roller: Cat. No. 1492-PROLLLAB	1	1492-MDM6X17-W
	Marking Tag <ul style="list-style-type: none"> Each tag 6 x 12 mm (0.236 x 0.472 in) White, PC-ABS, TPU, halogen-free, clip-in foot Ambient temperature range -50...+90 °C (-58...+194 °F) Qty: 600/roll 	Ribbon: Cat. No.1492-PRIBTB Roller: Cat. No. 1492-PROLLTB	1	1492-MT6X12

Specifications

Table 1 - Main Circuits

		100-KR		100/104-K			
		05	09	05	09	12	12
AC-1 Active Power Load (50 Hz); Ambient temperature 40 °C (104 °F)							
Rated Operational Current, I_e	≤ 500V	[A]	10	10	20	20	20
	690V	[A]	10	10	20	20	20
Rated Operational Power, P_e	230V	[kW]	4	4	8	8	8
	240V	[kW]	4	4	8.3	8.3	8.3
	400V	[kW]	6.9	6.9	14	14	14
	415V	[kW]	7	7	14	14	14
	500V	[kW]	8.7	8.7	17	17	17
	690V	[kW]	12	12	24	24	24
AC-1 Active Power Load (50 Hz); Ambient temperature 60 °C (140 °F)							
Rated Operational Current, I_e	≤ 500V	[A]	10	10	16	16	16
	690V	[A]	10	10	16	16	16
Rated Operational Power, P_e	230V	[kW]	4	4	6.4	6.4	6.4
	240V	[kW]	4	4	6.7	6.7	6.7
	400V	[kW]	6.9	6.9	11	11	11
	415V	[kW]	7	7	12	12	12
	500V	[kW]	8.7	8.7	14	14	14
	690V	[kW]	12	12	19	19	19
Switching of 3-phase Motors; (50 Hz) Ambient temperature 60 °C (140 °F), AC-2, AC-3							
Rated Operational Current, I_e	230V	[A]	6.3	8.5	6.3	11.3	11.3
	240V	[A]	6.3	8.5	6.3	11.3	11.3
	400V	[A]	4.9	8.5	4.9	8.5	11.5
	415V	[A]	4.9	8.5	4.9	8.5	11.5
	500V	[A]	3.9	6.8	3.9	6.8	9.2
	690V	[A]	2.8	4.9	2.8	4.9	6.7
Rated Operational Power, P_e	230V	[kW]	1.5	2.2	1.5	3	3
	240V	[kW]	1.5	2.2	1.5	3	3
	400V	[kW]	2.2	4	2.2	4	5.5
	415V	[kW]	2.2	4	2.2	4	5.5
	500V	[kW]	2.2	4	2.2	4	5.5
	690V	[kW]	2.2	4	2.2	4	5.5
Load Carrying Capacity per UL/CSA							
General Purpose Current (enclosed)		[A]	9	9	12	15	18
Rated current (enclosed), 1-phase	115V	[A]	7.2	7.2	9.8	9.8	13.8
	230V	[A]	6.9	8	8	10	12
Rated power (enclosed), 1-phase	115V	[Hp]	1/3	1/3	0.5	0.5	0.75
	230V	[Hp]	3/4	1	1	1.5	2
Rated current (enclosed), 3-phase	200V	[A]	6.9	7.8	6.9	7.8	11
	230V	[A]	6	6.8	6	6.8	9.6
	460V	[A]	4.8	7.6	4.8	7.6	11
	575V	[A]	3.9	6.1	3.9	6.1	9
Rated power (enclosed), 3-phase	200V	[Hp]	1.5	2	1.5	2	3
	230V	[Hp]	1.5	2	1.5	2	3
	460V	[Hp]	3	5	3	5	7.5
	575V	[Hp]	3	5	3	5	7.5

Table 2 - Main Circuits

		100/104-K		05	09	12
Switching of 3-phase Motors, (50 Hz); Ambient temperature 60 °C (140 °F), AC-4						
Rated Operational Current, I_e	230V	[A]	6.3	11.3	11.3	
	240V	[A]	6.3	11.3	11.3	
	400V	[A]	4.9	8.5	11.5	
	415V	[A]	4.9	8.5	11.5	
	500V	[A]	3.9	6.8	9.2	
	690V	[A]	2.8	4.9	6.7	
Rated Operational Power, P_e	230V	[Hp]	1.5	3	3	
	240V	[Hp]	1.5	3	3	
	400V	[Hp]	2.2	4	5.5	
	415V	[Hp]	2.2	4	5.5	
	500V	[Hp]	2.2	4	5.5	
	690V	[Hp]	2.2	4	5.5	
AC-4 at approximately 200,000 operations						
Rated Operational Current, I_e	230V	[A]	2.3	3.9	3.9	
	240V	[A]	2.3	3.9	3.9	
	400/415V	[A]	2	3.6	3.6	
	500V	[A]	1.9	3.2	3.2	
Rated Operational Power, P_e	230V ⁽¹⁾	[Hp]	0.37	0.75	0.75	
	240V ⁽¹⁾	[Hp]	0.37	0.75	0.75	
	400V ⁽¹⁾	[Hp]	0.75	1.5	1.5	
	415V ⁽¹⁾	[Hp]	0.75	1.5	1.5	
	500V ⁽¹⁾	[Hp]	0.75	1.5	1.5	
Max. switching frequency		Ops/hour	250	250	250	
Wye-Delta (60 Hz)						
Rated Operational Power, P_e	200V	[Hp]	2.2	3	5	
	230V	[Hp]	2.2	3	5	
	460V	[Hp]	5	7.5	10	
	575V	[Hp]	5	7.5	10	
Star-Delta Starting (50 Hz)						
Rated Operational Current, I_e	≤ 230V	[A]	11.3	20	20	
	≤ 240V	[A]	11.3	20	20	
	400V	[A]	8.5	15.5	15.5	
	415V	[A]	8.5	15.5	15.5	
	500V	[A]	6.8	12.4	12.4	
	690V	[A]	4.9	8.9	8.9	
Rated Operational Power, P_e	230V ⁽¹⁾	[kW]	3	5.5	5.5	
	240V ⁽¹⁾	[kW]	3	5.5	5.5	
	400V ⁽¹⁾	[kW]	4	7.5	7.5	
	415V ⁽¹⁾	[kW]	4	7.5	7.5	
	500V ⁽¹⁾	[kW]	4	7.5	7.5	
	690V ⁽¹⁾	[kW]	4	7.5	7.5	

(1) Power ratings at 50 Hz: Preferred values according to IEC 60072-1

Table 3 - Main Circuits

100/104-K		05	09	12	
Switching of Power Transformers, AC-6a (50 Hz)					
Inrush Current _____ = n Rated transformer current					
n= 30	≤ 230V	[A]	2.9	5.4	5.4
	≤ 240V	[A]	2.9	5.4	5.4
	≤ 400V	[A]	2.4	4.1	5.4
	≤ 415V	[A]	2.4	4.1	5.4
	≤ 500V	[A]	1.8	3.2	3.2
Apparent Power	230V	[kVA]	1.2	2	2
	240V	[kVA]	1.2	2	2
	400V	[kVA]	1.7	2.8	3.4
	415V	[kVA]	1.7	2.8	3.4
	500V	[kVA]	1.7	2.8	3.4
	690V	[kVA]	2	4	5
Switching of Lamps					
Gas discharge lamps AC-5a, 40 °C (104 °F)					
open	[A]	18	18	18	
enclosed	[A]	14.5	14.5	14.5	
Individually compensated:					
Max. capacitance at expected					
Short-circuit current of	10 kA	[μF]	750	750	750
	20 kA	[μF]	400	400	400
Filament AC-5b	230/240V	[A]	5	9	9
Switching of Low Inductive Loads in Home Appliances and Similar Applications per IEC 61095 (50 Hz)					
AC-7a	230V	[A]	20	20	20
	400V	[A]	20	20	20
Switching of Motor Load for Home Appliances (50 Hz)					
AC-7b	230V	[A]	6	11	11
	400V	[A]	6	11	11
Switching of Hermetically Sealed Cooling Compressor Motors - manual reset of overload release (50 Hz)					
AC-8a	400V	[A]	11	18	18
	500V	[A]	10	15	15
Switching of DC Loads					
Non-inductive or slightly inductive loads or resistance furnaces DC-1, 60 °C (140 °F)					
1 pole	24V	[A]	6	9	9
	48/60V	[A]	4/1	6/1.5	6/1.5
	110V	[A]	0.6	1	1
	220V	[A]	0.2	0.3	0.3
	440V	[A]	0.08	0.1	0.1
2 poles in series	24V	[A]	6	9	9
	48/60V	[A]	6	8	8
	110V	[A]	4	6	6
	220V	[A]	0.8	1.2	1.2
	440V	[A]	0.2	0.3	0.3
3 poles in series	24V	[A]	6	9	9
	48/60V	[A]	6	9	9
	110V	[A]	6	9	9
	220V	[A]	3	4	4
	440V	[A]	0.4	0.6	0.6

Table 3 - Main Circuits (Continued)

100/104-K		05	09	12	
Shunt-wound Motors					
Starting, reverse current braking, reversing, stepping DC-3, 60 °C (140 °F)					
3 poles in series	24V	[A]	5	9	9
	48/60V	[A]	4	6	6
	110V	[A]	2	3	3
	220V	[A]	0.8	1.2	1.2
	440V	[A]	0.15	0.2	0.2
Series-wound Motors					
Starting, reverse current braking, reversing, stepping DC-5, 60 °C (140 °F)					
3 poles in series	24V	[A]	5	9	9
	48/60V	[A]	2	3	3
	110V	[A]	0.6	1	1
	220V	[A]	0.1	0.1	0.1
Short Time Withstand I_{CW} , 60 °C (140 °F)	10 s	[A]	60	96	96
Resistance and Power Dissipation					
Main current circuit resistance	[mΩ]	2.2	2.2	2.2	
Power dissipation by all circuits at I_e AC-3/ 400V	[W]	0.3	0.9	0.9	
Total power dissipation					
At I_e AC-3/400V	AC control	[W]	2.1	2.7	2.7
	DC control	[W]	2.9	3.5	3.5
Lifespan					
Mechanical AC control	[Million operations]	15	15	15	
Mechanical DC control	[Million operations]	15	15	15	
Electrical AC-3 (400 V)	[Million operations]	0.7	0.7	0.7	
Weight					
AC	Non-Rev.	[kg (lbs.)]	0.16 (0.35)		
	Rev.	[kg (lbs.)]	0.4 (0.88)		
DC	Non-Rev.	[kg (lbs.)]	0.2 (0.44)		
	Rev.	[kg (lbs.)]	0.48 (1.06)		

Table 4 - Conductors

	100-KR		100/104-K		
	05	09	05	09	12
Conductor Cross Sections - Main Contacts Terminal type					
	1 conductor	[mm ²]	0.50...2.5		0.75...2.5
	2 conductors	[mm ²]	0.50...2.5		0.75...2.5
	1 conductor	[mm ²]	0.75...2.5 ⁽²⁾		1...4
	2 conductors	[mm ²]	0.75...2.5 ⁽²⁾		1...2.5+1...4
Recommended torque	[N·m]	-		1.2	
Cross section per UL/CSA	[AWG]	18...14 ⁽²⁾		18...12	
Recommended torque	[lb·in]	-		10.6	

(1) Pozidriv No. 2 / Blade No. 3 screw
(2) Fine- or coarse-stranded only

Table 5 - Short-Circuit Coordination Data⁽¹⁾

100/104-K		05	09	12
Short Circuit Coordination (Max. Fuse or Circuit Breaker Rating) Per IEC 60947-4-1 (contactor and fuses only)				
DIN Fuses- gG, gL		50 kA Available Fault Current		
Type "1" (690V)	[A]	35	35	35
Type "2" (400V)	[A]	16	20	20
Per UL 508 and CSA 22.2 No. 14 (contactor and fuses or circuit breaker only)				
UL Class K5 and RK5 Fuses		5 kA Available Fault Current		
UL Listed Combination (600V)	[A]	40	40	40
UL Class CC and CSA HRCI-MISC Fuses		50 kA Available Fault Current		
UL Listed Combination (600V)	[A]	30	30	30
UL Class J and CSA HRCI-J Fuses		50 kA Available Fault Current		
UL Listed Combination (600V)	[A]	30	30	30

(1) See the Rockwell Automation Global SCCR Tool at rok.auto/sccr for complete short-circuit current ratings.

Table 6 - Coil Data

100/104-K		05	09	12
Operating Limits				
50 Hz, 60 Hz, 50/60 Hz	pick-up	[x U _s]	0.85...1.1	
	dropout	[x U _s]	0.2...0.75	
DC (conventional)	pick-up	[x U _s]	0.8...1.1 0.7...1.25 ⁽¹⁾	
	dropout	[x U _s]	0.1...0.75	
Coil Consumption				
50 Hz, 60 Hz, 50/60 Hz	pick-up	[VA]	35	
	hold-in	[VA/W]	5/1.8	
DC (conventional)	pick-up	[W]	cold 3.0, warm 2.6	
	hold-in	[W]	cold 3.0, warm 2.6	
Operating Times				
AC	closing delay	[ms]	15...40	
	opening delay	[ms]	15...33	
With RC module	closing delay	[ms]	15...28	
DC (conventional)	opening delay	[ms]	18...40	
	closing delay	[ms]	6...12	
With integrated diode	opening delay	[ms]	8...12	
With external diode	opening delay	[ms]	35...50	

(1) For 9, 12, 24, and 110V DC coils.

Table 7 - Auxiliary Contacts and Auxiliary Contact Blocks



Conventional Coils		Internal	Front mounted
Switching of AC Loads			
AC-12 I _{th}	at 40 °C (104 °F)	[A]	10
	at 60 °C (140 °F)	[A]	6
AC-15 at rated voltage of	24V	[A]	6
	42/48V	[A]	6
	120V	[A]	6
	230V	[A]	3
	240V	[A]	3
	400V	[A]	1.8
	415V	[A]	1.8
	500V	[A]	1.4
	690V	[A]	1.0
Switching of DC Loads			
DC-12 L/R < 1 ms resistive loads at	24V DC	[A]	6
	48V DC	[A]	4
	110V DC	[A]	0.6
	220V DC	[A]	0.2
	440V DC	[A]	0.08
DC-14L/R <15 ms inductive loads with economy resistor in series at	24V DC	[A]	4
	48V DC	[A]	2.5
	110V DC	[A]	0.4
	220V DC	[A]	0.12
DC-13 switching electromagnets at	440V DC	[A]	0.05
	24V DC	[A]	2.8
	48V DC	[A]	1.2
	110V DC	[A]	0.55
	220V DC	[A]	0.27
Fuse gG		[A]	10
		[A]	10
	Min. switching capacity according to IEC 60947-5-4		15V/ 10 mA
Load Carrying Capacity per UL/CSA			
Rated voltage	AC	[V]	max.600
Continuous rating	at 40 °C (104 °F)	[A]	10
Switching capacity	AC	[A]	A600 B600
Rated voltage	DC	[V]	max.600
Switching capacity	DC	[A]	Q600

Table 8 - General

Attribute		Value
Rated Isolation Voltage U_i		
IEC	[V]	690
UL, CSA	[V]	600
Rated Impulse Voltage Withstand U_{imp}	[kV]	6
Rated Voltage U_e		
AC 50/60 Hz	[V]	230, 240, 400, 415, 460, 500, 575, 690
DC	[V]	24, 48, 110, 220, 440
Insulation Class of the Coil		Class F per IEC 60085 Class 105 insulation system per UL 508
Rated coil frequency		AC 50/60 Hz, DC
Ambient Temperature		
Storage	[°C (°F)]	-55...+80 (-67...176)
Operation at rated voltage	[°C (°F)]	-25...+60 (-13...140)
at 70 °C (158 °F)		15% current reduction against 60 °C (140 °F) values
Climatic Withstand		IEC60068-2-30
Max. Altitude of Installation Site	[m]	2000 NN, per IEC60947-4
Protection Class		IP2X
Single contactor cover		–
Contactors with frame terminal block		–
Auxiliary contact		IP2X
Protection against Accidental Contact		–
Resistance to Shock		IEC60068-2
Resistance to Vibration		IEC60068-2
Mechanically Linked Contacts IEC60947-5-1,AnnexL		100-K... (on main device)
Mirror Contacts IEC60947-4 Annex F		100-K...+100-KF...

Table 9 - Standards Compliance and Certifications

Standards Compliance	Certifications
IEC/EN 60947-1,-4-1,-5-1,-5-4	CE Marked
UL 508	CCC
CSA 22.2. No. 14	cULus Listed (File No. E41850, Guide NLDX, NLDX7)
NF F 62-000	
Meets the material restrictions for European Directive 2002/95/IEC-EU-RoHS	

Life-Load Curves

Figure 1 - AC-3, Switching of squirrel-cage motors while starting /AC-1, Non- or slightly inductive loads, resistance furnaces

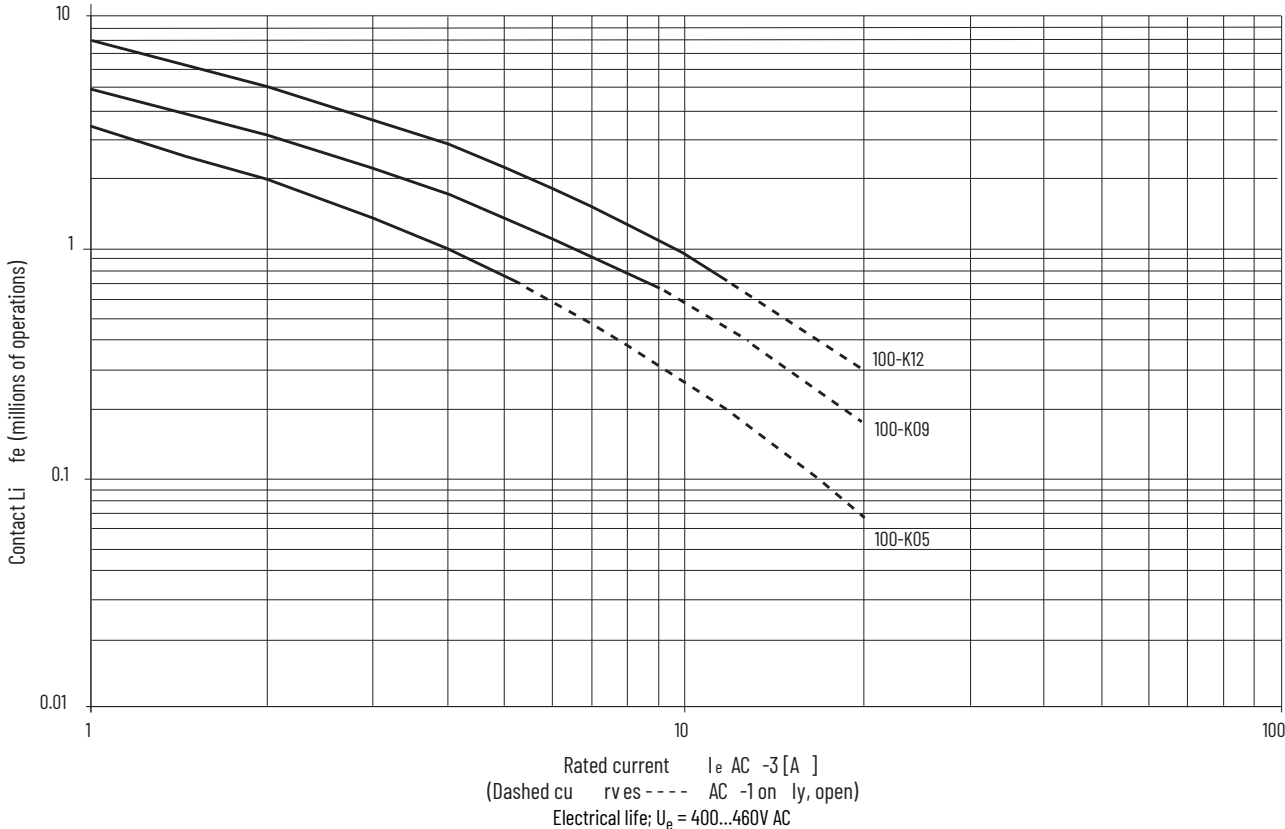
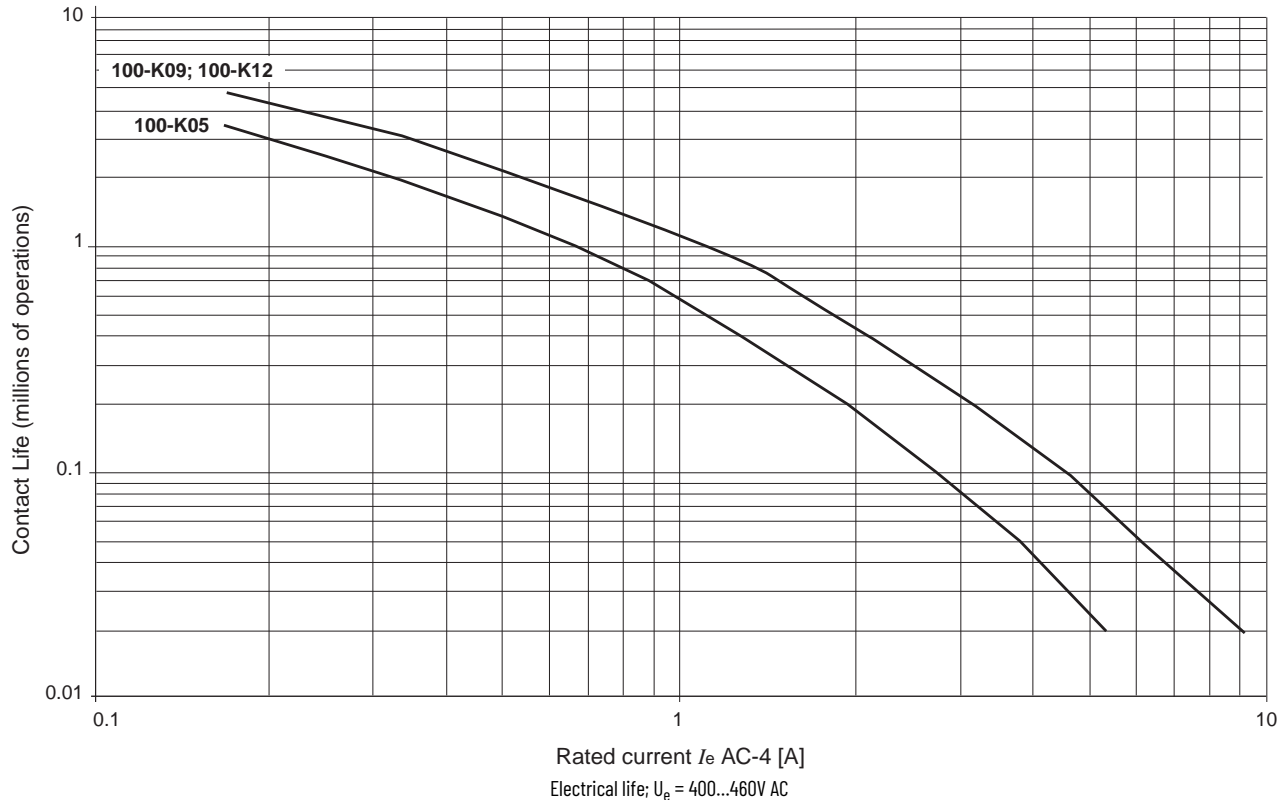

Figure 2 - AC-4, Stepping of squirrel-cage motors



Approximate Dimensions

Dimensions are shown in millimeters (inches). Dimensions are not intended for manufacturing purposes.

Figure 3 - 100-K Miniature Contactor with 193-K Overload Relay

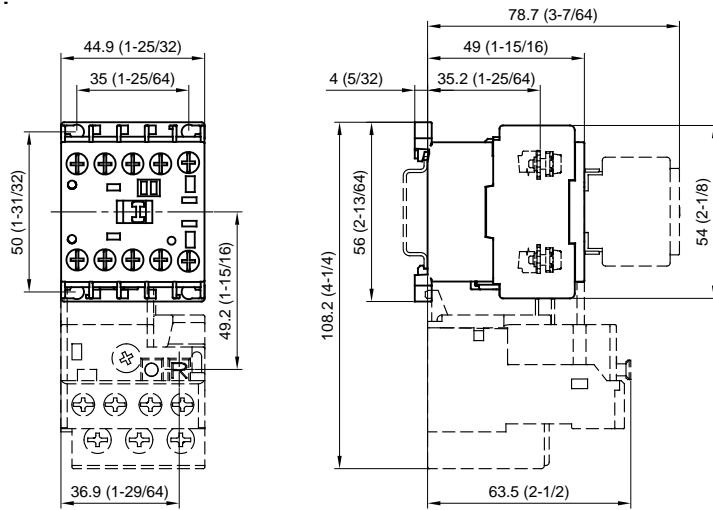
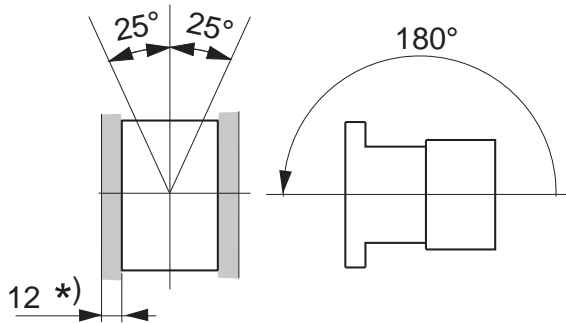

Figure 4 - Mounting Position



*) - Minimum distance to grounded parts or walls

Product Selection—100-C/104-C Contactors

- Compact sizes from 4...55 kW/5...75 Hp (9...97 A)
- Common accessories for all contactor sizes
- Front and side mounting of auxiliary contacts
- Electronic and pneumatic timing modules
- Space-saving coil-mounted control modules
- Reversible coil terminations (line or load side)
- All devices can be attached to 35 mm DIN mounting Rail
- Environmentally friendly materials





100-C Contactor



104-C Reversing Contactor

The Bulletin 100-C/104-C IEC contactor family, along with a wide range of common accessories and Bulletin 193 solid-state overload relays, provides the most compact and flexible starter component system available.

3-Pole AC- and DC-operated Contactors



Rated Operational Current I_e [A]		Ratings for switching AC motors - AC-2, AC-3, AC-4										Auxiliary Contacts		Cat. No.
		3-phase kW (50 Hz)				Hp (60 Hz)								
40 °C (104 °F)		230V	400/415V	500V	690V	1-Phase		3-Phase				N.O.	N.C.	
AC-3	AC-1					115V	230V	200V	230V	460V	575V			
9	32	3	4	4	4	1/2	1-1/2	2	2	5	7-1/2	1	0	100-C09 \otimes 10
												0	1	100-C09 \otimes 01 ⁽¹⁾
12	32	4	5.5	5.5	5.5	1/2	2	3	3	7-1/2	10	1	0	100-C12 \otimes 10
												0	1	100-C12 \otimes 01 ⁽¹⁾
16	32	5.5	7.5	7.5	7.5	1	3	5	5	10	15	1	0	100-C16 \otimes 10
												0	1	100-C16 \otimes 01 ⁽¹⁾
23	32	7.5	11	13	10	2	3	5	7-1/2	15	15	1	0	100-C23 \otimes 10
												0	1	100-C23 \otimes 01 ⁽¹⁾
30	65	10	15	15	15	2	5	7-1/2	10	20	25	0	0	100-C30 \otimes 00
												1	0	100-C30 \otimes 10
												0	1	100-C30 \otimes 01 ⁽²⁾
												0	0	100-C37 \otimes 00
37	65	11	18.5/20	20	18.5	3	5	10	10	25	30	1	0	100-C37 \otimes 10
												0	1	100-C37 \otimes 01 ⁽²⁾
												0	0	100-C43 \otimes 00
												1	0	100-C43 \otimes 10
43	85	13	22	25	22	3	7-1/2	10	15	30	30	0	1	100-C43 \otimes 01 ⁽²⁾
												1	0	100-C43 \otimes 10
												0	0	100-C55 \otimes 00
55	85	15	30	30	30	5	10	15	20	40	40	1	0	100-C55 \otimes 10
												0	1	100-C55 \otimes 01 ⁽²⁾
												0	0	100-C60 \otimes 00
60	100	18.5	32	37	32	5	10	15	20	40	50	1	0	100-C60 \otimes 10
												0	1	100-C60 \otimes 01 ⁽²⁾
												0	0	100-C72 \otimes 00
72	100	22	40	45	40	5	15	20	25	50	60	1	0	100-C72 \otimes 10
												0	1	100-C72 \otimes 01 ⁽²⁾
												0	0	100-C85 \otimes 00
85	100	25	45	55	45	7-1/2	15	25	30	60	60	1	0	100-C85 \otimes 10
												0	1	100-C85 \otimes 01 ⁽²⁾
												0	0	100-C97 \otimes 00
97	130	30	55	55	55	10	20	30	30	75	75	1	0	100-C97 \otimes 10
												0	1	100-C97 \otimes 01 ⁽²⁾
												0	0	100-C97 \otimes 00

(1) N.C. auxiliary contact meets mechanically linked performance per IEC 60947-5-1, Annex L.

(2) N.C. auxiliary contact meets mirror contact performance per IEC 60947-4-1, Annex F.

⊗ Coil voltage code and terminal position—see [page 19](#)



4-Pole AC- and DC-Operated Contactors

Rated Operational Current I_e [A]		Ratings for switching AC motors - AC-2, AC-3										Contact Configuration, Main Poles		Cat. No.			
		3-phase kW (50 Hz) ⁽¹⁾				Hp (60 Hz)											
		230V	400/415V	500V	690V	1-Phase		3-Phase ⁽¹⁾									
115V	230V					200V	230V	460V	575V	N.O.	N.C.						
40 °C (104 °F)		AC-3		AC-1													
9	32	3	4	4	4	1/2	1-1/2	2	2	5	7-1/2	4	0	100-C09⊗400			
												3	1	100-C09⊗300			
												2	2	100-C09⊗200			
12	32	4	5.5	5.5	5.5	1/2	2	3	3	7-1/2	10	4	0	100-C12⊗400			
												3	1	100-C12⊗300			
												2	2	100-C12⊗200			
16	32	5.5	7.5	7.5	7.5	1	3	5	5	10	10	4	0	100-C16⊗400			
												3	1	100-C16⊗300			
												2	2	100-C16⊗200			
23	32	7.5	11	13	10	2	3	5	7-1/2	15	15	4	0	100-C23⊗400			
												3	1	100-C23⊗300			
												2	2	100-C23⊗200			
37	75	11	18.5/20	20	18.5	3	5	10	10	25	30	4	0	100-C40⊗400			
												2	2	100-C40⊗200			
85	130	25	45	55	45	7-1/2	15	25	30	60	50	4	0	100-C90⊗400			
												2	2	100-C90⊗200			

(1) Three-phase ratings apply only to contactors with at least three N.O. power poles.

⊗ Coil voltage code and terminal position— see [page 19](#).

Reversing AC- and DC-Operated Contactors

Rated Operational Current I_e [A]		Ratings for switching AC motors - AC-2, AC-3, AC-4										Auxiliary Contacts per Contactor		Cat. No.			
		3-phase kW (50 Hz)				Hp (60 Hz)											
		230V	400/415V	500V	690V	1-Phase		3-Phase									
115V	230V					200V	230V	460V	575V	N.O.	N.C. ⁽¹⁾						
40 °C (104 °F)		AC-3		AC-1													
9	32	3	4	4	4	1/2	1-1/2	2	2	5	7-1/2	1	1	104-C09⊗22			
12	32	4	5.5	5.5	5.5	1	2	3	3	7-1/2	10	1	1	104-C12⊗22			
16	32	5.5	7.5	7.5	7.5	1	3	5	5	10	15	1	1	104-C16⊗22			
23	32	7.5	11	13	10	2	3	5	7-1/2	15	20	1	1	104-C23⊗22			
30	65	10	15	15	15	2	5	7-1/2	10	20	25	0	1	104-C30⊗02			
												1	1	104-C30⊗22			
37	65	11	18.5/20	20	18.5	3	5	10	10	25	30	0	1	104-C37⊗02			
												1	1	104-C37⊗22			
43	85	13	22	25	22	3	7.5	10	15	30	30	0	1	104-C43⊗02			
												1	1	104-C43⊗22			
55	85	15	30	30	30	5	10	15	20	40	40	0	1	104-C55⊗02			
												1	1	104-C55⊗22			
60	100	18.5	32	37	32	5	10	15	20	40	50	0	1	104-C60⊗02			
												1	1	104-C60⊗22			
72	100	22	40	45	40	5	15	20	25	50	60	0	1	104-C72⊗02			
												1	1	104-C72⊗22			
85	100	25	45	55	45	7-1/2	15	25	30	60	60	0	1	104-C85⊗02			
												1	1	104-C85⊗22			
97	130	30	55	55	55	10	15	30	30	75	75	0	1	104-C97⊗02			
												1	1	104-C97⊗22			

(1) The N.C. auxiliary contact is supplied as part of the mechanical/electrical interlock.

⊗ Coil voltage code and terminal position— see [page 19](#).

Coil Voltage Codes

The Cat. No. as listed is incomplete. Select a coil voltage code from the table below to complete the Cat. No. Example: 120V, 60 Hz: Cat. No. 100-C09⊗10 becomes Cat. No.100-C09D10.

AC Voltages [V]	24	110	120	200... 220	208... 240	230	240	277	400... 415	440	480
50 Hz	—	D	—	L	—	—	T	—	G	B	—
60 Hz	—	—	D	—	L	—	—	T	—	G	B
50/60 Hz	KJ	—	—	—	—	KF	—	—	—	—	—

DC Voltages [V]		12	24	36...48	48...72	72	110	110...125	220	220...250
100-C09...C55	Electronic with Integrated Diode	EQ	EJ	EW	EY	—	—	ED	—	EA
100-C60...C97	with Integrated Diode	—	DJ	—	—	DG	DD	—	DA	—

Coil Terminal Position

All contactors are delivered with the coil terminals located on the line side.

For load-side coil terminations, insert a "U" prior to the coil voltage code. Ordering example: Cat. No. 100-C09UD10.



Cat. No.100-C09⊗10 Line Side

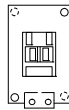

Cat. No.100-C09U⊗10 Load Side

Assignment of Contacts

Table valid for: AC / DC = 0.85...1.1 x U_s, T_{amb} = -25 °C...+60 °C (-13...140 °F), normal position (horizontal rail mounting)

Device Combinations in Accordance with IEC 60947-1 / -4-1

Auxiliary Contact Blocks		100-C Contactors (AC and DC Control)						
Circuit Diagram	Control	100-C09_⊗10 100-C12_⊗10 100-C16_⊗10 100-C23_⊗10	100-C09_⊗01 100-C12_⊗01 100-C16_⊗01 100-C23_⊗01	100-C30_⊗00 100-C37_⊗00 100-C43_⊗00 100-C55_⊗00 100-C60_⊗00 100-C72_⊗00 100-C85_⊗00 100-C97_⊗00	100-C09_⊗400 100-C12_⊗400 100-C16_⊗400 100-C23_⊗400 100-C40_⊗400 100-C90_⊗400	100-C09_⊗300 100-C12_⊗300 100-C16_⊗300 100-C23_⊗300	100-C09_⊗200 100-C12_⊗200 100-C16_⊗200 100-C23_⊗200 100-C40_⊗200 100-C90_⊗200	

Side Mounting ⁽¹⁾

100-SB01		AC/DC	10 + 01 = 11	01 + 01 = 02 ⁽²⁾	00 + 01 = 01	00 + 01 = 01	00 + 01 = 01	00 + 01 = 01
100-SB10		AC/DC	10 + 10 = 20 ⁽²⁾	01 + 10 = 11	00 + 10 = 10	00 + 10 = 10	00 + 10 = 10	00 + 10 = 10
100-SB02		AC/DC	10 + 02 = 12 ⁽²⁾	—	00 + 02 = 02	00 + 02 = 02	00 + 02 = 02	00 + 02 = 02
100-SB11		AC/DC	10 + 11 = 21 ⁽²⁾	01 + 11 = 12 ⁽²⁾	00 + 11 = 11	00 + 11 = 11	00 + 11 = 11	00 + 11 = 11
100-SB20		AC/DC	10 + 20 = 30 ⁽²⁾	01 + 20 = 21 ⁽²⁾	00 + 20 = 20	00 + 20 = 20	00 + 20 = 20	00 + 20 = 20
100-SBL11 ⁽³⁾		AC/DC	10 + L11 = L21 ⁽²⁾	01 + L11 = L12 ⁽²⁾	00 + L11 = L11	00 + L11 = L11	00 + L11 = L11	00 + L11 = L11

(1) Up to 8 auxiliary contacts possible: contactor + front mounted (AC max. 4 N.C. / DC max. 4 N.C.), side mounted (AC max. 2 N.O. / DC max. 2 N.O. and max. 2 N.C.).

(2) Double numbering; because of double numbering only left-side mounting is recommended.

(3) Early make and/or late break.

Device Combinations in Accordance with IEC 60947-1 / -4-1

Auxiliary Contact Blocks		100-C Contactors (AC and DC Control)						
Circuit Diagram	Control	100-C09_⊗10 100-C12_⊗10 100-C16_⊗10 100-C23_⊗10	100-C09_⊗01 100-C12_⊗01 100-C16_⊗01 100-C23_⊗01	100-C30_⊗00 100-C37_⊗00 100-C43_⊗00 100-C55_⊗00 100-C60_⊗00 100-C72_⊗00 100-C85_⊗00 100-C97_⊗00	100-C09_⊗400 100-C12_⊗400 100-C16_⊗400 100-C23_⊗400 100-C40_⊗400 100-C90_⊗400	100-C09_⊗300 100-C12_⊗300 100-C16_⊗300 100-C23_⊗300	100-C09_⊗200 100-C12_⊗200 100-C16_⊗200 100-C23_⊗200 100-C40_⊗200 100-C90_⊗200	
Front Mounting (1)								
100-FA02, 100-FAB02		AC/DC	10 + 02 = 12	01 + 02 = 03	00 + 02 = 02	00 + 02 = 02	00 + 02 = 02	00 + 02 = 02
100-FA11, 100-FAB11		AC/DC	10 + 11 = 21	01 + 11 = 12	00 + 11 = 11	00 + 11 = 11	00 + 11 = 11	00 + 11 = 11
100-FB11, 100-FBB11		AC/DC	—	—	00 + 11 = 11	00 + 11 = 11	00 + 11 = 11	00 + 11 = 11
100-FC11, 100-FCB11		AC/DC	10 + 11 = 21	—	—	—	—	—
100-FA20, 100-FAB20		AC/DC	10 + 20 = 30	01 + 20 = 21	00 + 20 = 20	00 + 20 = 20	00 + 20 = 20	00 + 20 = 20
100-FBL11 (2)		AC/DC	—	—	00 + L11 = L11	00 + L11 = L11	00 + L11 = L11	00 + L11 = L11
100-FA22, 100-FAB22		AC/DC	10 + 22 = 32	01 + 22 = 23	00 + 22 = 22	00 + 22 = 22	00 + 22 = 22	00 + 22 = 22
100-FB22, 100-FBB22		AC/DC	—	—	00 + 22 = 22	00 + 22 = 22	00 + 22 = 22	00 + 22 = 22
100-FC22, 100-FCB22		AC/DC	10 + 22 = 32	—	—	—	—	—
100-FA31, 100-FAB31		AC/DC	10 + 31 = 41	01 + 31 = 32	00 + 31 = 31	00 + 31 = 31	00 + 31 = 31	00 + 31 = 31
100-FA40, 100-FAB40		AC/DC	10 + 40 = 50	01 + 40 = 41	00 + 40 = 40	00 + 40 = 40	00 + 40 = 40	00 + 40 = 40
100-FAL22 (2)		AC/DC	10 + L22 = L32	01 + L22 = L23	00 + L22 = L22	00 + L22 = L22	00 + L22 = L22	00 + L22 = L22
100-FA04, 100-FAB04		AC/DC	10 + 04 = 14	01 + 04 = 05	00 + 04 = 04	00 + 04 = 04	00 + 04 = 04	00 + 04 = 04
100-FA13, 100-FAB13		AC/DC	10 + 13 = 23	01 + 13 = 14	00 + 13 = 13	00 + 13 = 13	00 + 13 = 13	00 + 13 = 13

Device Combinations in Accordance with IEC 60947-1 / -4-1 (Continued)

Auxiliary Contact Blocks		100-C Contactors (AC and DC Control)						
Circuit Diagram	Control	100-C09_⊗10 100-C12_⊗10 100-C16_⊗10 100-C23_⊗10	100-C09_⊗01 100-C12_⊗01 100-C16_⊗01 100-C23_⊗01	100-C30_⊗00 100-C37_⊗00 100-C43_⊗00 100-C55_⊗00 100-C60_⊗00 100-C72_⊗00 100-C85_⊗00 100-C97_⊗00	100-C09_⊗400 100-C12_⊗400 100-C16_⊗400 100-C23_⊗400 100-C40_⊗400 100-C90_⊗400	100-C09_⊗300 100-C12_⊗300 100-C16_⊗300 100-C23_⊗300	100-C09_⊗200 100-C12_⊗200 100-C16_⊗200 100-C23_⊗200 100-C40_⊗200 100-C90_⊗200	
100-FB02, 100-FBB02		AC/DC	10 + 02 = 12	01 + 02 = 03	00 + 02 = 02	00 + 02 = 02	00 + 02 = 02	00 + 02 = 02
100-FB20, 100-FBB20		AC/DC	10 + 20 = 30	01 + 20 = 21	00 + 20 = 20	00 + 20 = 20	00 + 20 = 20	00 + 20 = 20
100-FC31, 100-FCB31		AC/DC	10 + 31 = 41	01 + 31 = 32	00 + 31 = 31	00 + 31 = 31	00 + 31 = 31	00 + 31 = 31

(1) Up to 8 auxiliary contacts possible: contactor + front mounted (AC max. 4 N.C. / DC max. 4 N.C.), side mounted (AC max. 2 N.O. / DC max. 2 N.O. and max. 2 N.C.).
 (2) Early make and/or late break.

Product Selection—100S-C/104S-C Safety Contactors

- Mechanically linked N.C. auxiliary contacts
- Front-mounted auxiliary contacts
 - Gold bifurcated
 - Protective cover to prevent manual operation
 - Permanently fixed
 - Red contact housing for easy identification
 - “Mechanically Linked” or “Mirror Contact” symbol
- AC and DC operating coils
- SUVA Third-party certification
- Reversing contactors:
 - 3 Main contacts
 - Include reversing power wiring
- Include mechanical/electrical Interlock



100S-C Safety Contactor



104S-C Reversing Safety Contactor

Bulletin 100S-C/104S-C safety contactors provide mechanically linked positively guided contacts, required in feedback circuits of modern safety applications. The mechanically linked N.C. auxiliary contacts do not change state when a power pole welds. In addition, the gold-plated bifurcated auxiliary contacts are ideally suited for low-energy applications or feedback control circuits with multiple series-connected N.C. auxiliary contacts.

3-Pole AC- and DC-operated Contactors

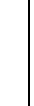
Rated Operational Current I_e [A]		Ratings for switching AC motors - AC-2, AC-3, AC-4										Auxiliary Contacts		Cat. No. ⁽¹⁾ ⁽²⁾
		3-phase kW (50 Hz)				Hp (60 Hz)								
40 °C (104 °F)		230V	400/415V	500V	690V	1-Phase		3-Phase						
AC-3	AC-1					115V	230V	200V	230V	460V	575V	N.O.	N.C.	
9	32	3	4	4	4	1/2	1-1/2	2	2	5	7-1/2	0	5	100S-C09⊗05BC
												1	4	100S-C09⊗14BC
12	32	4	5.5	5.5	5.5	1/2	2	3	3	7-1/2	10	0	5	100S-C12⊗05BC
												1	4	100S-C12⊗14BC
16	32	5.5	7.5	7.5	7.5	1	3	5	5	10	15	0	5	100S-C16⊗05BC
												1	4	100S-C16⊗14BC
23	32	7.5	11	13	10	2	3	5	7-1/2	15	15	0	5	100S-C23⊗05BC
												1	4	100S-C23⊗14BC
30	65	10	15	15	15	2	5	7-1/2	10	20	25	0	4	100S-C30⊗04BC
												1	4	100S-C30⊗14BC
37	65	11	18.5/20	20	18.5	3	5	10	10	25	30	0	4	100S-C37⊗04BC
												1	4	100S-C37⊗14BC
43	85	13	22	25	22	3	7-1/2	10	15	30	30	0	4	100S-C43⊗04BC
												1	4	100S-C43⊗14BC
55	85	15	30	30	30	5	10	15	20	40	40	0	4	100S-C55⊗04BC
												1	4	100S-C55⊗14BC
60	100	18.5	32	37	32	5	10	15	20	40	50	0	4	100S-C60⊗04BC ⁽³⁾
												1	4	100S-C60⊗14BC ⁽³⁾
72	100	22	40	45	40	5	15	20	25	50	60	0	4	100S-C72⊗04BC ⁽³⁾
												1	4	100S-C72⊗14BC ⁽³⁾
85	100	25	45	55	45	7-1/2	15	25	30	60	60	0	4	100S-C85⊗04BC ⁽³⁾
												1	4	100S-C85⊗14BC ⁽³⁾
97	130	30	55	55	55	10	15	30	30	75	75	0	4	100S-C97⊗04BC ⁽³⁾
												1	4	100S-C97⊗14BC ⁽³⁾





(1) For other contact configurations and full product details, please contact your local Rockwell Automation sales office or Allen-Bradley distributor.

(2) If standard cross-stamped front-mount auxiliary contacts are required, remove the letter “B” before the letter “C” in the cat. no. Example: Cat. No. 100S-C09⊗05BC becomes Cat. No. 100S-C09⊗05C.

(3) Front- and side-mount auxiliary contacts on Cat. Nos. 100S-C60...C97 conform to mirror contact performance only.

⊗ Coil voltage code and terminal position— see [page 26](#).



4-Pole AC- and DC-operated Contactors

Rated Operational Current I_e [A]		Ratings for Switching AC Motors										Contact Configuration				Cat. No. ^{(1) (2)}
		AC-2, AC-3, AC-4				Hp (60 Hz)						Main Pole		Auxiliary Contacts		
		3-Phase kW (50 Hz) ⁽³⁾				1-Phase		3-Phase ⁽³⁾								
AC-3	AC-1	230V	400V/415V	500V	690V	115V	230V	200V	230V	460V	575V	N.O.	N.C.	N.O.	N.C.	
9	32	3	4	4	4	1/2	1-1/2	2	2	5	7-1/2	4	0	0	4	100S-C09⊗404BC
																3
12	32	4	5.5	5.5	5.5	1/2	2	3	3	7-1/2	10	4	0	0	4	100S-C12⊗404BC
																3
16	32	5.5	7.5	7.5	7.5	1	3	5	5	10	15	4	0	0	4	100S-C16⊗404BC
																3
23	32	7.5	11	13	10	2	3	5	7-1/2	15	15	4	0	0	4	100S-C23⊗404BC
																3

- (1) For other contact configurations and full product details, please contact your local Rockwell Automation sales office or Allen-Bradley distributor.
- (2) If standard cross-stamped front-mount auxiliary contacts are required, remove the letter "B" before the letter "C" in the cat. no. Example: Cat. No. 100S-C09⊗404BC becomes Cat. No. 100S-C09⊗404C.
- (3) Three-phase ratings only apply to contactors with at least three N.O. power poles.

⊗ Coil voltage code and terminal position— see [page 26](#).

Reversing AC- and DC-operated Contactors

Rated Operational Current I_e [A]		Ratings for switching AC motors - AC-2, AC-3, AC-4										Auxiliary Contacts		Cat. No. ^{(1) (2)}	
		3-phase kW (50 Hz)				Hp (60 Hz)									
40 °C (104 °F)	AC-3	AC-1	230V	400/415V	500V	690V	1-Phase		3-Phase						N.O.
							115V	230V	200V	230V	460V	575V			
9	32	3	4	4	4	1/2	1-1/2	2	2	5	7-1/2	0	6	104S-C09⊗012BC	
												1	5	104S-C09⊗210BC	
12	32	4	5.5	5.5	5.5	1/2	2	3	3	7-1/2	10	0	6	104S-C12⊗012BC	
												1	5	104S-C12⊗210BC	
16	32	5.5	7.5	7.5	7.5	1	3	5	5	10	15	0	6	104S-C16⊗012BC	
												1	5	104S-C16⊗210BC	
23	32	7.5	11	13	10	2	3	5	7-1/2	15	15	0	6	104S-C23⊗012BC	
												1	5	104S-C23⊗210BC	
30	65	10	15	15	15	2	5	7-1/2	10	20	25	0	5	104S-C30⊗010BC	
												1	5	104S-C30⊗210BC	
37	65	11	18.5/20	20	18.5	3	5	10	10	25	30	0	5	104S-C37⊗010BC	
												1	5	104S-C37⊗210BC	
43	85	13	22	25	22	3	7-1/2	10	15	30	30	0	5	104S-C43⊗010BC	
												1	5	104S-C43⊗210BC	
55	85	15	30	30	30	5	10	15	20	40	40	0	5	104S-C55⊗010BC	
												1	5	104S-C55⊗210BC	
60	100	18.5	32	37	32	5	10	15	20	40	50	0	5	104S-C60⊗010BC ⁽⁴⁾	
												1	5	104S-C60⊗210BC ⁽⁴⁾	
72	100	22	40	45	40	5	15	20	25	50	60	0	5	104S-C72⊗010BC ⁽⁴⁾	
												1	5	104S-C72⊗210BC ⁽⁴⁾	
85	100	25	45	55	45	7-1/2	15	25	30	60	60	0	5	104S-C85⊗010BC ⁽⁴⁾	
												1	5	104S-C85⊗210BC ⁽⁴⁾	
97	130	30	55	55	55	10	15	30	30	75	75	0	5	104S-C97⊗010BC ⁽⁴⁾	
												1	5	104S-C97⊗210BC ⁽⁴⁾	

(1) For other contact configurations and full product details, please contact your local Rockwell Automation sales office or Allen-Bradley distributor.

(2) If standard cross-stamped front-mount auxiliary contacts are required, remove the letter "B" before the letter "C" in the cat. no. Example: Cat. No. 104S-C09⊗05BC becomes Cat. No. 104S-C09⊗05C.

(3) One of the N.C. auxiliary contacts is supplied as part of the mechanical/electrical interlock.

(4) Front- and side-mount auxiliary contacts on Cat. Nos. 104S-C60...C97 conform to mirror contact performance only.

⊗ Coil voltage code and terminal position— see [page 26](#).

Coil Voltage Codes

The Cat. No. as listed is incomplete. Select a coil voltage code from the table below to complete the Cat. No. Example: 120V, 60 Hz: Cat. No. 100S-C09⊗05BC becomes Cat. No.100S-C09D05BC.

AC Voltages [V]	24	110	120	200... 220	208... 240	230	240	277	400... 415	440	480
50 Hz	—	D	—	L	—	—	T	—	G	B	—
60 Hz	—	—	D	—	L	—	—	T	—	G	B
50/60 Hz	KJ	—	—	—	—	KF	—	—	—	—	—

DC Voltages [V]		12	24	36...48	48...72	72	110	110...125	220	220...250
100S-C09...C55	Electronic with Integrated Diode	EQ	EJ	EW	EY	—	—	ED	—	EA
100S-C60...C97	with Integrated Diode	—	DJ	—	—	DG	DD	—	DA	—

Coil Terminal Position

All contactors are delivered with the coil terminals located on the line side.

For load side coil terminations, insert a “U” prior to the coil voltage code. Ordering example: Cat. No. 100S-C09UD05BC.



Cat. No.100S-C09⊗05CLine Side

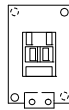

Cat. No.100S-C09U⊗05CLoad Side

Assignment of Contacts

Figure 5 - Safety Contactors with 3 Main Contacts and Standard Front-mount Auxiliary Contacts

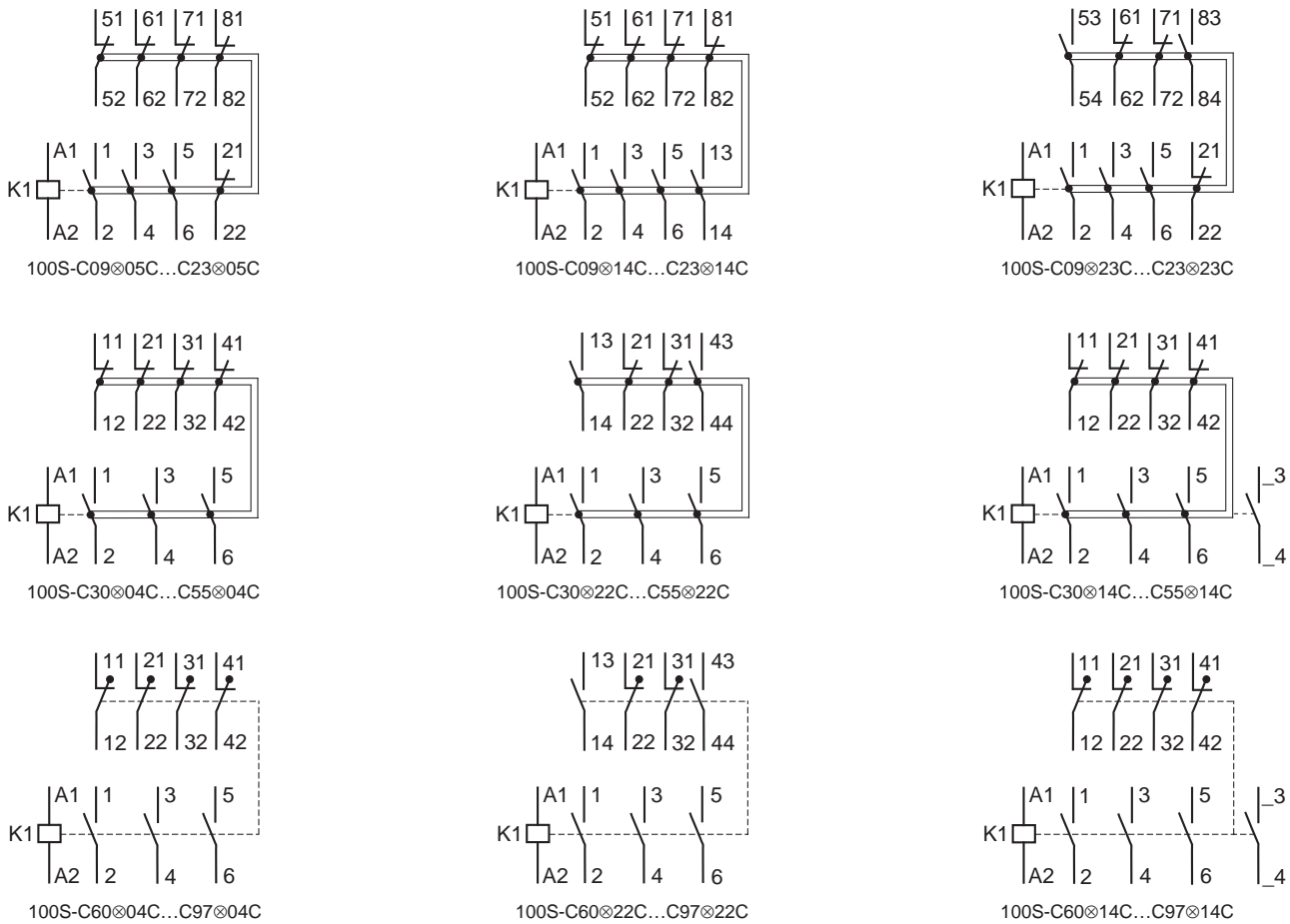

Figure 6 - Safety Contactors with 4 Main Contacts and Standard Front-mount Auxiliary Contacts

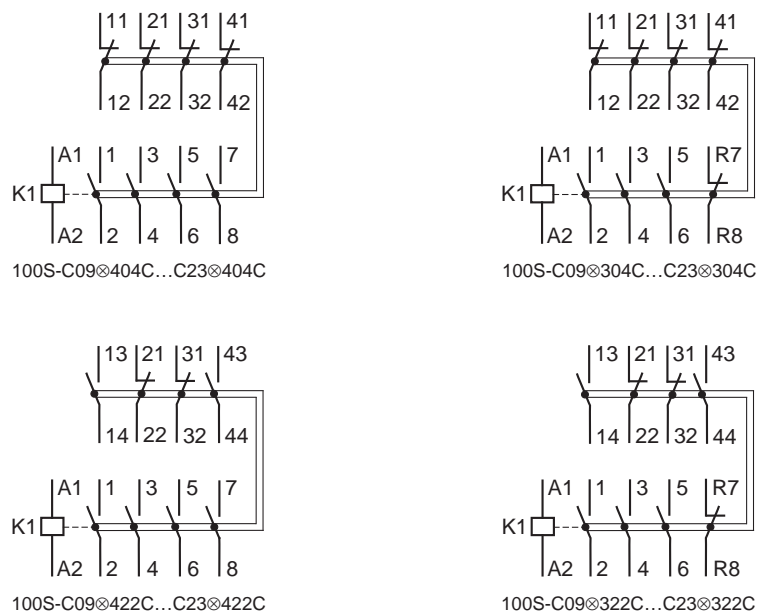

Figure 7 - Safety Reversing Contactors with 3 Main Contacts and Standard Front-mount Auxiliary Contacts

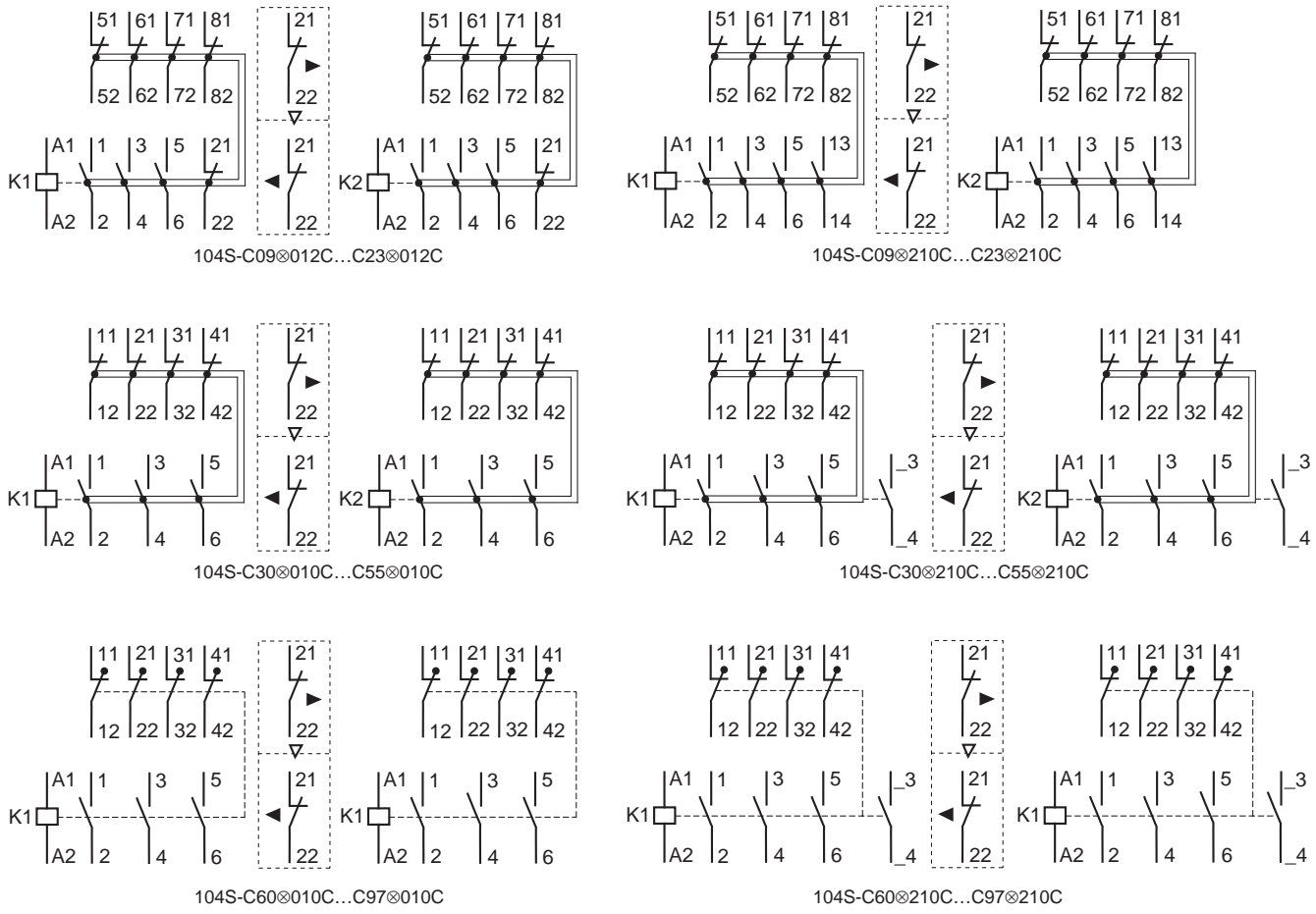

Figure 8 - Safety Contactors with 3 Main Contacts and Bifurcated Front-mount Auxiliary Contacts

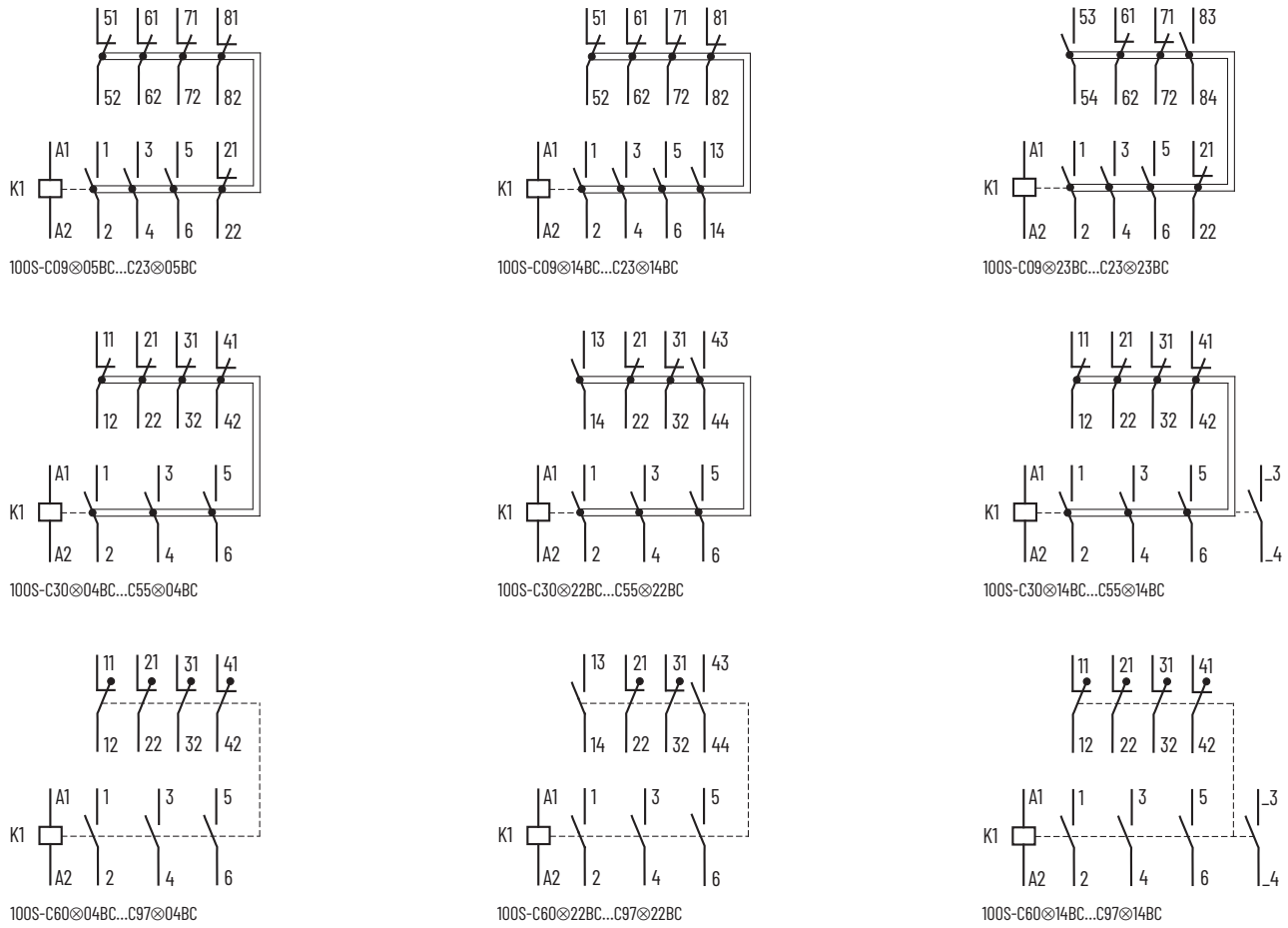

Figure 9 - Safety Contactors with 4 Main Contacts and Bifurcated Front-mount Auxiliary Contacts

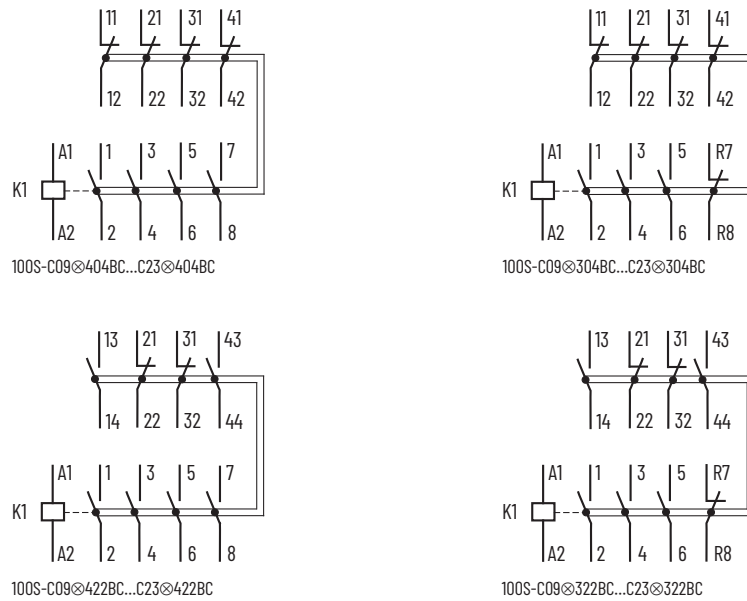
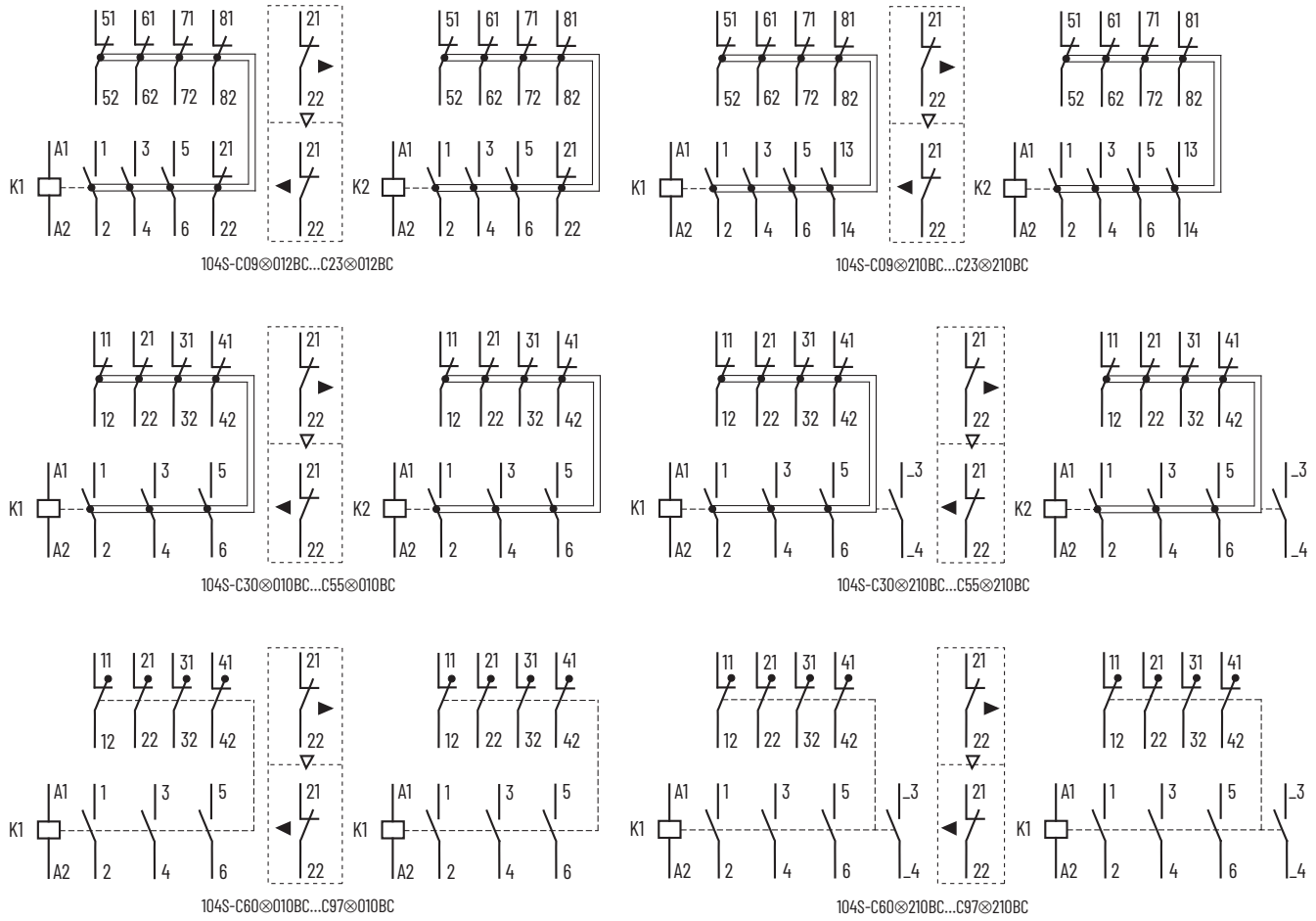

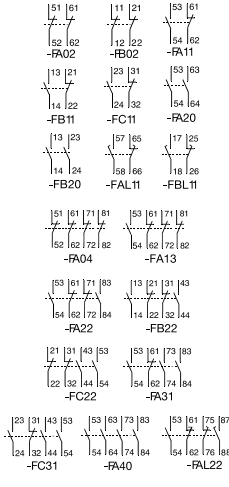

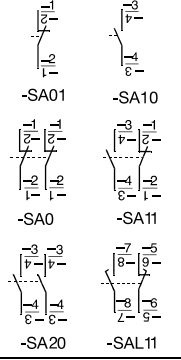

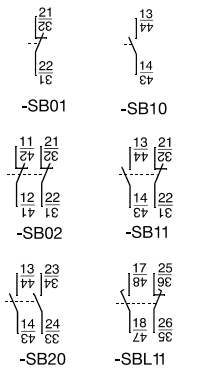

Figure 10 - Safety Reversing Contactors with 3 Main Contacts and Bifurcated Front-mount Auxiliary Contacts



Accessories















Auxiliary Contact Blocks

	Description ⁽¹⁾	Connection Diagrams			For Use With	Cat. No.			
			N.O.	N.C.		Standard Auxiliary Contact ⁽²⁾	Bifurcated Auxiliary Contact		
 <p>Auxiliary Contact Blocks for Front Mounting</p> <ul style="list-style-type: none"> • 2- and 4-pole • Quick and easy mounting without tools • Electronic-compatible contacts down to 17V, 5mA • Mechanically linked performance between N.O. and N.C. poles and to the main contactor poles (except for L types) • Models with equal function with several terminal numbering choices • 1L = Late break N.C. / early make N.O. • Bifurcated version for switching down to 5V, 3 mA also available 		0	2	100-C all	100-FA02	100-FAB02			
						C30⊗00...C97⊗00	100-FB02	100-FBB02	
						100-C all	100-FA11	100-FAB11	
						C30⊗00...C97⊗00	100-FB11	100-FBB11	
						C09⊗10...C23⊗10	100-FC11	100-FCB11	
						100-C all	100-FA20	100-FAB20	
						C30⊗00...C97⊗00	100-FB20	100-FBB20	
					1L	1L	100-C all	100-FAL11	—
							C30⊗00...C97⊗00	100-FBL11	—
					0	4	100-C all	100-FA04	100-FAB04
					1	3	100-C all	100-FA13	100-FAB13
							100-C all	100-FA22	100-FAB22
					2	2	C30⊗00...C97⊗00	100-FB22	100-FBB22
							C09⊗10...C23⊗10	100-FC22	100-FCB22
					3	1	100-C all	100-FA31	100-FAB31
					C09⊗10...C23⊗10	100-FC31	100-FCB31		
			4	0	100-C all	100-FA40	100-FAB40		
			1+1L	1+1L	100-C all	100-FAL22	—		
 <p>Auxiliary Contact Blocks for Side Mounting without Sequence Terminal Designations</p> <ul style="list-style-type: none"> • 1- and 2-pole • Two-way numbering for right or left mounting on the contactor • Quick and easy mounting without tools • Electronic-compatible contacts down to 17V, 10 mA • Mirror contact performance to the main contactor poles • 1L = Late break N.C. / early make N.O. 		0	1	100-C all	100-SA01	—			
				1	0	100-C all	100-SA10	—	
				0	2	100-C all	100-SA02	—	
				1	1	100-C all	100-SA11	—	
				2	0	100-C all	100-SA20	—	
				1L	1L	100-C all	100-SAL11	—	
 <p>Auxiliary Contact Blocks for Side Mounting with Sequence Terminal Designations</p> <ul style="list-style-type: none"> • 1- and 2-pole • Two-way numbering for right or left mounting on the contactor • Quick and easy mounting without tools • Electronic-compatible contacts down to 17V, 10 mA • Mirror contact performance to the main contactor poles • 1L = Late break N.C. / early make N.O. 		0	1	100-C	100-SB01	—			
				1	0	100-C ⁽³⁾	100-SB10	—	
				0	2	100-C ⁽³⁾	100-SB02	—	
				1	1	100-C ⁽³⁾	100-SB11	—	
				2	0	100-C ⁽³⁾	100-SB20	—	
				1L	1L	100-C ⁽³⁾	100-SBL11	—	

(1) Max. number of auxiliary contacts that may be mounted:
 AC and 24V DC electronic coil contactors—max. 4 N.O. contacts on the front of the contactor, 2 N.O. contacts on the side, 4 N.C. front or side, 6 total. DC Coil contactors—max. 4 N.O. contacts on the front of the contactor or max. 2 N.O. contacts on the side, 4 N.C. front or side, 4 total.
 (2) For screwless terminals (front mount only), insert "CR" after the "100-" in the catalog number. Example: Cat. No. 100-FA02 becomes Cat. No. 100-CRFA02.
 (3) Double numbering—Left-side mounting only is recommended for Cat. No. 100-C09...100-C23 due to double numbering.

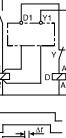
Control Modules

Timers

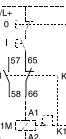
		Description	Connection Diagrams	For Use With	Cat. No.		
	On-Delay	Pneumatic Timing Modules • Pneumatic timing element contacts switch after the delay time. The contacts on the main control relay continue to operate without delay	0.3...30 s		100-C or 700-CF with AC or 24V DC electronic coils ⁽¹⁾	100-FPTA30	
			2...180 s			100-FPTA180	
	Off-Delay		0.3...30 s		100-C all, 700-CF all	100-FPTB30	
			2...180 s			100-FPTB180	
	On-delay	Electronic Timing Modules – On-delay • Delay of the contactor or control relay solenoid. The contactor or control relay is energized at the end of the delay time.	0.1...3 s		100-C or 700-CF with 110...240V, 50/60Hz coils	100-ETA3	
			1...30 s			100-ETA30	
			10...180 s			100-ETA180	
	Off-delay			0.1...3 s		100-C or 700-CF with 24VDC coils	100-ETAZJ3
				1...30 s			100-ETAZJ30
				10...180 s			100-ETAZJ180
	Off-delay	Electronic Timing Modules – Off-delay • Delay of the contactor or control relay solenoid. After interruption of the control signal, the contactor or control relay is de-energized at the end of the delay time.		0.3...3 s		100-C09...C37 or 700-CF with 24V 50/60Hz	100-ETBKJ3
				1...30 s			100-ETBKJ30
				10...180 s			100-ETBKJ180
	Transition Time Y			0.3...3 s		100-C or 700-CF with 110...240V 50/60Hz coils	100-ETB3
				1...30 s			100-ETB30
				10...180 s			100-ETB180
	Transition Time Y	Electronic Timing Modules • Delay of the contactor solenoid. Contactor K 3(Y) is de-energized (off) and K 2 (Δ) is energized (on) after the end of the set Y end time. (Switching delay at 50 ms.) • Continuous adjustment range • High repeat		Transition Time Y Contactor 1...30 s		100-C with 110...240V 50/60Hz coils	100-ETY30
	Mechanical Interlocks	• For interlocking of two contactors. • Common interlock for most Bul. 100-C contactor sizes • Interlocking of different sizes possible • Mechanical and electrical interlocking possible in one module by means of integrated auxiliary contacts • 9 mm dovetail connector included		Mechanical only, without auxiliary contacts		100-C (except 100-C40, -C90)	100-MCA00
				Mechanical/ electrical interlock with 2 N.C. auxiliary contacts			
	Mechanical Latch	• Following contactor latching, the contactor coil is immediately de-energized (off) by the N.C. auxiliary contact (65-66). • Electrical or manual release • 1 N.O. + 1 N.C. auxiliary contacts • Suitable for all Bul. 100-C contactor sizes, 9...97 A	Maximum command duration 0.03...10 s		100-C with AC or 24V DC electronic coils (except 100-C90)	100-FL11⊗	



(1) Cannot be used with side-mounted auxiliary contacts on 700-CF DC relays.

Coil Voltage Code: The Cat. No. as listed is incomplete. Select a coil voltage code from the table below to complete the Cat. No. Example: 120V, 60 Hz: Cat. No. 100-FL11⊗ becomes Cat. No.100-FL11D

AC Voltages [V] ⁽¹⁾	24	48	100	110	120	230...240	240	277	380...400	400...415	440	480
50 Hz	K	Y	KP	D	—	VA	KA	—	N	G	B	—
60 Hz	J	—	—	—	D	—	KA	T	—	—	N	B

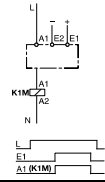

(1) For special voltages, consult your local Rockwell Automation sales office or Allen-Bradley distributor.

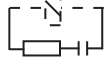
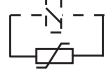
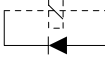
Additional Control Modules

	Description		Voltage Range	Connection Diagrams	For Use With	Cat. No.
	DC Interface (Electronic) <ul style="list-style-type: none"> Interface between the DC control signal (PLC) and the AC operating mechanism of the contactor. Requires no additional surge suppression on the relay coils. 		Input: 12V DC Output: 110...240V AC		100-C with AC coils 110...240V AC	100-JE12
			Input: 18...30V DC Output: 110...240V AC			100-JE
			Input: 48V DC Output: 110...240V AC			100-JE48
	Surge Suppressors <ul style="list-style-type: none"> For limitation of coil switching transients. Plug-in, coil mounted. Suitable for 100-C contactor sizes, 9...97 A. RC, varistor, and diode versions. 	RC Module AC operating mechanism	24...48V AC, 50/60 Hz		100-C with Coils	100-FSC48 ⁽¹⁾
			110...280V AC, 50/60 Hz			100-FSC280 ⁽¹⁾
			380...480V AC, 50/60 Hz			100-FSC480 ⁽¹⁾
	Varistor Module AC/DC operating mechanism	12...55V AC, 12...77V DC		100-C with AC coils or 100-C09...-C43 with DC coils	100-FSV55 ⁽¹⁾	
		56...136V AC/78...180V DC			100-FSV136 ⁽¹⁾	
		137...277V AC/ 181...350V DC			100-FSV277 ⁽¹⁾	
		278...575V AC			100-FSV575 ⁽¹⁾	
	Diode Module DC operating mechanism	1...30 s 10...180 s		100-C09...-C43 with DC coils	100-FSD250 ⁽¹⁾	

(1) For screwless terminals, insert "CR" after the "100-" in the catalog number. Example: Cat No. 100-FSC48 becomes Cat. No.-CRFSC48.

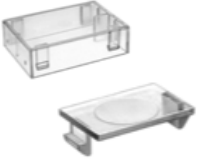
Assembly Components (For 100-C09...C97 contactors)

	Description	For Use With	Pkg. Qty.	Cat. No.
	Dovetail Connectors <ul style="list-style-type: none"> For use in contactor and starter assemblies Single Connector – 0 mm spacing 	100-C	10	100-S0
	Dovetail Connectors <ul style="list-style-type: none"> For use in contactor and starter assemblies Single Connector – 9 mm spacing 		10	100-S9
	Protective Covers <ul style="list-style-type: none"> Provides protection against unintended manual operation For contactors and front-mounted auxiliary contacts, pneumatic timers, and latches 	100-C all	1	100-SCCA
		100-FA, -FB, -FC, -FP, -FL	10	100-SCFA
	Reversing Power Wiring Kits <ul style="list-style-type: none"> For reversing connection with a solid-state or thermal overload relay 	100-C09...C23	1	105-PW23
		100-C30...C37	1	105-PW37
		100-C43...C55	1	105-PW55
		100-C60...C97	1	105-PW85
	DIN (#3) symmetrical hat rail <ul style="list-style-type: none"> 35 x 7.5 x 1 m 	140M-D 140M-F 100-C all	10	199-DR1





Wye-Delta/Star-Delta Starter Kits

Wye-Delta power wiring kits are designed to aid in the field assembly of open-transition Wye-delta starters that use Bulletin 100-C contactors. These kits include line, load, and start-point (shorting) connections. Assembling a Wye-delta starter requires the following additional components:

- Contactors
- Overload Relay
- Cat. No. 100-MCA02 Mechanical/Electrical Interlock
- Cat. No. 100-ETY30 Electronic Y-ΔTimer
- Cat. No. 100-S9 Base Coupler for 1M to 2M contactor (optional)





	3-Phase Rating											Pkg Qty.	Cat. No.
	kW (50 Hz)				Hp (60 Hz)				Use with Cat. No. 100-				
	230V	380/415V	500V	690V	200V	230V	460V	575V	Delta		Wye		
									1M	2M	1S		
	5.5	7.5	7.5	7.5	5	5	10	10	C09	C09	C09	1	170-PW23
	7.5	11	11	10	5	7.5	15	15	C12	C12	C09	1	170-PW23
	10	15	15	13	7.5	10	20	20	C16	C16	C12	1	170-PW23
	13	22	22	18.5	7.5	10	25	25	C23	C23	C12	1	170-PW23
	17	25	25	25	10	15	30	30	C30	C30	C16	1	170-PW37
	20	37	32	32	15	20	40	40	C37	C37	C23	1	170-PW37
	22	40	40	40	20	25	50	50	C43	C43	C30	1	170-PW55
	30	45	45	45	25	30	60	60	C55	C55	C37	1	170-PW55
	32	55	55	55	30	40	75	75	C60	C60	C37	1	170-PW72
	40	63	63	63	40	50	100	100	C72	C72	C43	1	170-PW72
	50	80	80	80	50	60	125	125	C85	C85	C60	1	170-PW85
50	90	90	90	50	60	125	125	C97	C97	C60	1	170-PW85	

Marking Systems (For 100-C09...C97 contactors)

	Description	Pkg. Qty. ⁽¹⁾	Cat. No.
	Adhesive labels <ul style="list-style-type: none"> • Each label 6 x 17 mm (0.236 x 0.67 in) • White, halogen-free polyester, with acrylate adhesive • Ambient temperature range -40...+120 °C (-40...+248 °F) • Qty: 3000/roll 	1	1492-MDM6X17-W
	Label Sheet <ul style="list-style-type: none"> • 105 self-adhesive paper labels each, 6 x 17 mm 	10	100-FMS
	Marking Tag Sheet <ul style="list-style-type: none"> • 106 perforated paper labels each, 6 x 17 mm, to be used with a transparent cover 	10	100-FMP
	Transparent Cover <ul style="list-style-type: none"> • To be used with marking tag sheets 	100	100-FMC
	Marking Tag Adapters <ul style="list-style-type: none"> • To be used with 1492W marking tag system 	100	100-FMA2

(1) Must be ordered in multiples of package quantities

Terminal Kits (For 100-C09...C97 contactors)

	Description	Max. Current Ratings and Wire Sizes		Pkg. Qty ⁽¹⁾	Cat. No.
	Stab Connector Kit • Dual stab (0.250 in.) for 100-C coil terminals • For 100-C09...C97 contactors			20	199-SC2
	Stab Connector Kit • Dual stab (0.250 in.) for 100-C power terminals • For 100-C09...C23 contactors			100	199-SC10
	3-Pole Terminal Lug Kit • For Cat. No. 100-C09...C23 (Line side)	IEC @ 40 °C IEC @ 40 °C UL/CSA (Encl.)	45 A (4...16 mm ² , fine stranded w/ ferrule) ⁽²⁾ 45 A (4...25 mm ² , coarse stranded/solid) 40 A (#10...4 AWG, stranded/solid)	1	100-CTN23
	3-Pole Terminal Lug Kit • For Cat. No. 100-C09...C23 (Load side)	IEC @ 40 °C IEC @ 40 °C UL/CSA (Encl.)	45 A (4...16 mm ² , fine stranded w/ ferrule) 45 A (4...25 mm ² , coarse stranded/solid) 40 A (#10...4 AWG, stranded/solid)	1	100-CTL23
	3-Pole Terminal Lug Kit • For Cat. No. 100-C30...C37 (Line and load side)	IEC @ 40 °C IEC @ 40 °C UL/CSA (Encl.)	60 A (4...16 mm ² , fine stranded w/ ferrule) 60 A (4...25 mm ² , coarse stranded/solid) 55 A (#10...4 AWG, stranded/solid)	1	100-CT37
	1-Pole Terminal Lug Kit • For Cat. No. 100-C43	IEC @ 40 °C IEC @ 40 °C UL/CSA (Encl.)	90 A (6...35 mm ² , fine stranded w/ ferrule) 90 A (6...50 mm ² , coarse stranded/solid) 75 A (#8...2 AWG, stranded/solid)	3	100-CT43
	3-Pole Paralleling Kit • For Cat. No. 100-C09...C23	IEC @ 40 °C IEC @ 40 °C UL/CSA (Encl.)	100 A (35...70 mm ² , fine stranded w/ ferrule) 100 A (35...95 mm ² , coarse stranded/solid) 100 A (#0...2/0 AWG, stranded/solid)	2	100-CP23
	3-Pole Paralleling Kit • For Cat. No. 100-C30...C37	IEC @ 40 °C IEC @ 40 °C UL/CSA (Encl.)	150 A (35...70 mm ² , fine stranded w/ ferrule) 150 A (35...95 mm ² , coarse stranded/solid) 150 A (#0...2/0 AWG, stranded/solid)	2	100-CP37

(1) Must be ordered in multiples of the package quantity.
 (2) 16 mm² max. according to IEC 60947; actual max. 25 mm²

SEMI-F47 Voltage Sag Immunity Module

	Description	Input Voltage	For Use With ⁽¹⁾	Options	Cat. No.
	SEMI-F47 Module • Meets SEMI-F47 voltage sag immunity requirements • Direct mounting to coil terminals of 100-C contactors and 700-CF control relays • Requires DC coil contactor • Optional 1...30 s ON-delay timer version	24...240V AC	100-C60...C97	without timer	100-CSF47
		110...240V AC	100-C60...C97	with 1...30 s ON-delay timer	100-CSF47A30

(1) Contactor must have DC coil at the same voltage as AC input. Example: for 24V AC control, select Cat. No. 100-C09ZJ10 (24V DC coil).

Renewal Parts

Replacement Coils for AC Contactors



AC Standard Control Voltages [V]			AC Coil Code	100-C09...100-C16	100-C23...100-C37, 100L-C20	100-C40...100-C55	100-C60...100-C85	100-C90...100-C97
50 Hz	60 Hz	50/60 Hz		Cat. No.	Cat. No.	Cat. No.	Cat. No.	Cat. No.
—	12	—	Q	TA006	TC006	TD006	TE006	TF006
12	—	—	R	TA404	TC404	TD404	TE404	TF404
—	24	—	J	TA013	TC013	TD013	TE013	TF013
24	—	—	K	TA407	TC407	TD407	TE407	TF407
—	—	24	KJ	TA855	TC855	TD855	TE855	TF855
32	36	—	V	TA481	TC481	TD481	TE481	TF481
36	42	—	W	TA410	TC410	TD410	TE410	TF410
42	48	—	X	TA482	TC482	TD482	TE482	TF482
48	—	—	Y	TA414	TC414	TD414	TE414	TF414
—	—	48	KY	TA860	TC860	TD860	TE860	TF860
100	100...110	100	KP	TA861	TC861	TD861	TE861	TF861
110	120	—	D	TA473	TC473	TD473	TE473	TF473
—	—	110	KD	TA856	TC856	TD856	TE856	TF856
120	—	—	P	TA425	TC425	TD425	TE425	TF425
127	—	—	S	TA428	TC428	TD428	TE428	TF428
200	200...220	200	KG	TA862	TC862	TD862	TE862	TF862
—	208	—	H	TA049	TC049	TD049	TE049	TF049
200...220	208...240	—	L	TA296	TC296	TD296	TE296	TF296
—	—	200...230	KL	TA864	TC864	TD864	TE864	—
220	240	—	A	TA474	TC474	TD474	TE474	TF474
220...230	260	—	F	TA441	TC441	TD441	TE441	TF441
—	—	230	KF	TA851	TC851	TD851	TE851	TF851
230...240	—	—	VA	TA440	TC440	TD440	TE440	TF440
240	277	—	T	TA480	TC480	TD480	TE480	TF480
—	—	240	KA	TA858	TC858	TD858	TE858	TF858
—	347	—	I	TA065	TC065	TD065	TE065	TF065
—	380	—	E	TA067	TC067	TD067	TE067	TF067
380...400	440	—	N	TA071	TC071	TD071	TE071	TF071
—	—	400	KN	TA863	TC863	TD863	TE863	TF863
400...415	—	—	G	TA457	TC457	TD457	TE457	TF457
440	480	—	B	TA475	TC475	TD475	TE475	TF475
—	—	440	KB	TA859	TC859	TD859	TE859	TF859
500	—	—	M	TA479	TC479	TD479	TE479	TF479
550	600	—	C	TA476	TC476	TD476	TE476	TF476

Replacement Coils for DC Contactors



DC Control Voltage [V]	DC Coil Code	100-C09...100-C16, 100Q-C16	100-C23...100-C37, 100Q-C37	100-C40...100-C55 (Series A)	100-C40...100-C55 (Series B)	100-C60...100-C85	100-C90...100-C97
		Cat. No.	Cat. No.	Cat. No.	Cat. No.	Cat. No.	Cat. No.
9V Diode ⁽¹⁾	DR	—	—	—	—	TE766M	TF766M
12V Electronic ⁽²⁾	EQ	TC708E	TC708E	TD708E	TD708E2	—	—
12V Diode	DQ	—	—	—	—	TE708M	TF708M
24V Electronic ⁽²⁾	EJ	TC714E	TC714E	TD714E	TD714E2	—	—
24V Electronic ⁽³⁾	QJ	TC714Q	TC714Q	TD714Q	TD714Q2	—	—
24V Diode ⁽²⁾	DJ	—	—	—	—	TE714M	TF714M
36...48V Electronic ⁽²⁾	EW	TC719E	TC719E	TD719E	TD719E2	—	—
36V Diode	DW	—	—	—	—	TE719M	TF719M
48...72V Electronic	EY	TC724E	TC724E	TD724E	TD724E2	—	—
48V Diode	DY	—	—	—	—	TE724M	TF724M
60V Diode	DZ	—	—	—	—	TE774M	TF774M
64V Diode	DB	—	—	—	—	TE727M	TF727M
72V Diode	DG	—	—	—	—	TE728M	TF728M
80V Diode	DE	—	—	—	—	TE729M	TF729M
110...125V Electronic ⁽⁴⁾	ED	TC733E	TC733E	TD733E	TD733E2	—	—
110V Diode	DD	—	—	—	—	TE733M	TF733M
115V Diode	DP	—	—	—	—	TE734M	TF734M
125V Diode	DS	—	—	—	—	TE737M	TF737M
220...250V Electronic	EA	TC747E	TC747E	TD747E	TD747E2	—	—
220V Diode	DA	—	—	—	—	TE747M	TF747M
230V Diode	DF	—	—	—	—	TE749F	TF749F
250V Diode	DT	—	—	—	—	TE751F	TF751F

(1) Voltage operating range: 0.65...1.3 U_s(2) Voltage operating range: 0.7...1.25 U_s

(3) Faster drop-out time (16...21 ms)

(4) Voltage operating range: 0.7...1.25 U_s at 110V DC

Specifications

Table 10 - Main Circuits

		100/104-C, 100S/104S-C																
		09	12	16	23	30	37	40*200	40*400	43	55	60	72	85	90*200	90*400	97	
Coil Type:	Conventional	X	X	X	X	X	X	X	X	X	X	X	X	X	X	X	X	
	Electronic – EI	X	X	X	X	X	X	X	X	X	X	–	–	–	–	–	–	
AC-1 Active Power Load (50 Hz); Ambient temperature 40 °C (104 °F)																		
Rated Operational Current, I_e	≤500V	[A]	32	32	32	32(40) ⁽¹⁾	65	65	75	75	85	85	100	100	100	130	130	130
	690V	[A]	32	32	32	32(40) ⁽¹⁾	65	65	75	75	85	85	100	100	100	130	130	130
Rated Operational Power, P_e	230V	[kW]	13	13	13	13	26	26	30	30	34	34	40	40	40	52	52	52
	240V	[kW]	13	13	13	13	27	27	31	31	35	35	42	42	42	54	54	54
	400V	[kW]	22	22	22	22	45	45	52	52	59	59	69	69	69	90	90	90
	415V	[kW]	23	23	23	23	47	47	54	54	61	61	72	72	72	93	93	93
	500V	[kW]	28	28	28	28	56	56	65	65	74	74	87	87	87	113	113	113
	690V	[kW]	38	38	38	38	78	78	90	90	102	102	120	120	120	155	155	155
AC-1 Active Power Load (50 Hz); Ambient temperature 60 °C (140 °F)																		
Rated Operational Current, I_e	≤500V	[A]	32	32	32	32	65	65	60	60	75	75	100	100	100	110	110	110
	690V	[A]	32	32	32	32	65	65	60	60	75	75	100	100	100	110	110	110
Rated Operational Power, P_e	230V	[kW]	13	13	13	13	26	26	24	24	25	25	40	40	40	44	44	44
	240V	[kW]	13	13	13	13	27	27	25	25	26	26	42	42	42	46	46	46
	400V	[kW]	22	22	22	22	45	45	42	42	44	44	69	69	69	76	76	76
	415V	[kW]	23	23	23	23	47	47	43	43	45	45	72	72	72	79	79	79
	500V	[kW]	28	28	28	28	56	56	52	52	55	55	87	87	87	95	95	95
	690V	[kW]	38	38	38	38	78	78	72	72	75	75	120	120	120	131	131	131
Switching of 3-phase Motors; (50 Hz) Ambient temperature 60 °C (140 °F), AC-2, AC-3																		
Rated Operational Current, I_e	230V	[A]	12	15	20	26.5	35	38	38	38	44	56	62	72	85	85	85	96
	240V	[A]	12	15	20	26.5	35	38	38	38	44	56	62	72	85	85	85	95
	400V	[A]	9	12	16	23	30	37	37	37	43	55	60	72	85	85	85	97
	415V	[A]	9	12	16	23	30	37	37	37	43	55	60	72	85	85	85	97
	500V	[A]	7	10	14	20	25	30	29	30	38	44	55	67	80	80	80	78
	690V	[A]	5	7	9	12	18	21	9	21	25	25	34	42	49	22	49	57
Rated Operational Power, P_e	230V	[kW]	3	4	5.5	7.5	10	11	11	11	13	15	18.5	22	25	25	25	30
	240V	[kW]	3	4	5.5	7.5	10	11	11	11	13	15	18.5	22	25	25	25	30
	400V	[kW]	4	5.5	7.5	11	15	18.5	18.5	18.5	22	30	32	40	45	45	45	55
	415V	[kW]	4	5.5	7.5	11	15	20	20	20	22	30	32	40	45	45	45	55
	500V	[kW]	4	5.5	7.5	13	15	20	18.5	20	25	30	37	45	55	55	55	55
	690V	[kW]	4	5.5	7.5	10	15	18.5	7.5	18.5	22	22	32	40	45	18.5	45	55
Load Carrying Capacity per UL/CSA																		
General Purpose Current (enclosed)		[A]	25	25	30	30	55	60	60	60	75	75	90	90	100	125	130	120
Rated current (enclosed), 1-phase	115V	[A]	9.8	9.8	16	24	24	34	34	34	34	56	56	56	80	80	80	100
	230V	[A]	10	12	17	17	28	28	28	28	40	50	50	68	68	68	68	88
Rated power (enclosed), 1-phase	115V	[Hp]	0.5	0.5	1	2	2	3	3	3	3	5	5	5	7.5	7.5	7.5	10
	230V	[Hp]	1.5	2	3	3	5	5	5	5	7.5	10	10	15	15	15	15	20
Rated current (enclosed), 3-phase	200V	[A]	7.8	11	17.5	17.5	25.3	32.2	32.2	32.2	32.2	48.3	48.3	62.1	78.2	78.2	78.2	92
	230V	[A]	6.8	9.6	15.2	22	28	28	28	28	42	54	54	68	80	80	80	80
	460V	[A]	7.6	11	14	21	27	34	34	34	40	52	52	65	77	65	77	96
	575V	[A]	9	11	17	17	27	32	17	32	32	41	52	62	62	22	52	77
Rated power (enclosed), 3-phase	200V	[Hp]	2	3	5	5	7.5	10	10	10	10	15	15	20	25	25	25	30
	230V	[Hp]	2	3	5	7.5	10	10	10	10	15	20	20	25	30	30	30	30
	460V	[Hp]	5	7.5	10	15	20	25	25	25	30	40	40	50	60	50	60	75
	575V	[Hp]	7.5	10	15	15	25	30	15	30	30	40	50	60	60	20	50	75

(1) Values in () with increased cross-section and cable lug.

Table 11 - Main Circuits

			100/104-C, 100S/104S-C											
			09	12	16	23	30	37	43	55	60	72	85	97
Coil Type:	Conventional		X	X	X	X	X	X	X	X	X	X	X	X
	Electronic – EI		X	X	X	X	X	X	X	X	X	–	–	–
Switching of 3-phase Motors, (50 Hz); Ambient temperature 60 °C (140 °F), AC-4														
Rated Operational Current, I_e	230V	[A]	12	15	20	26.5	35	38	44	56	62	72	85	96
	240V	[A]	12	15	20	26.5	35	38	44	56	62	72	85	95
	400V	[A]	9	12	16	23	30	37	43	55	60	72	85	97
	415V	[A]	9	12	16	23	30	37	43	55	60	72	85	97
	500V	[A]	7	10	14	20	25	30	38	44	55	67	80	78
	690V	[A]	5	7	9	12	18	21	25	25	34	42	49	57
Rated Operational Power, P_e	230V	[kW]	3	4	5.5	7.5	10	11	13	15	18.5	22	25	30
	240V	[kW]	3	4	5.5	7.5	10	11	13	15	18.5	22	25	30
	400V	[kW]	4	5.5	7.5	11	15	18.5	22	30	32	40	45	55
	415V	[kW]	4	5.5	7.5	11	15	20	22	30	32	40	45	55
	500V	[kW]	4	5.5	7.5	13	15	20	25	30	37	45	55	55
	690V	[kW]	4	5.5	7.5	10	15	18.5	22	22	32	40	45	55
AC-4 at approximately 200,000 operations														
Rated Operational Current, I_e	230V	[A]	4.3	6.6	9	9	12	14	16.5	22	25.5	31	38	44
	240V	[A]	4.3	6.6	9	9	12	14	16.5	22	25.5	31	38	44
	400/415V	[A]	4.3	6.6	9	9	12	14	16.5	22	25.5	31	38	44
	500V	[A]	4.3	6.6	9	9	12	14	16.5	22	25.5	31	38	44
	690V	[A]	4.3	6.6	9	9	12	14	16.5	22	25.5	31	38	44
Rated Operational Power, P_e	230V ⁽¹⁾	[kW]	0.75	1.5	2.2	2.2	3	3.7	4	5.5	6.3	7.5	11	11
	240V ⁽¹⁾	[kW]	0.75	1.5	2.2	2.2	3	4	4	5.5	7.5	7.5	11	11
	400V ⁽¹⁾	[kW]	1.8	3	4	4	5.5	6.3	7.5	11	13	15	20	22
	415V ⁽¹⁾	[kW]	1.8	3	4	4	5.5	6.3	7.5	11	13	17	20	22
	500V ⁽¹⁾	[kW]	2.2	3.7	5.5	5.5	7.5	7.5	10	11	15	20	25	30
	690V ⁽¹⁾	[kW]	3	5.5	7.5	7.5	10	11	15	18.5	22	25	32	37
Max. switching frequency	Ops/hour	250	250	220	200	200	200	200	200	200	120	120	120	120
Wye-Delta (60 Hz) Rated Operational Power	200V	[Hp]	5	5	7-1/2	7-1/2	10	15	20	25	30	40	50	50
	230V	[Hp]	5	7-1/2	10	10	15	20	25	30	40	50	60	60
	460V	[Hp]	10	15	20	25	30	40	50	60	75	100	125	125
	575V	[Hp]	10	15	20	25	30	40	50	60	75	100	125	125
UL/CSA Elevator Duty Rated Operational Current	200V	[A]	7.8	11.0	11.0	17.5	25.3	25.3	32.2	TBD	32.2	48.3	62.1	TBD
	230V	[A]	6.8	9.6	15.2	15.2	22.0	28.0	28.0	TBD	42.0	54.0	68.0	TBD
	460V	[A]	7.6	11.0	14.0	21.0	27.0	27.0	34.0	TBD	40.0	52.0	65.0	TBD
	575V	[A]	6.1	9.0	11.0	17.0	22.0	27.0	32.0	TBD	41.0	52.0	62.0	TBD
UL/CSA Elevator Duty Rated Operational Power	200V	[Hp]	2	3	3	5	7-1/2	7-1/2	10	TBD	10	15	20	TBD
	230V	[Hp]	2	3	5	5	7-1/2	10	10	TBD	15	20	25	TBD
	460V	[Hp]	5	7-1/2	10	15	20	20	25	TBD	30	40	50	TBD
	575V	[Hp]	5	7-1/2	10	15	20	25	30	TBD	40	50	60	TBD

(1) Power ratings at 50 Hz: Preferred values according to IEC 60072-1

Table 12 - Main Circuits

		100/104-C, 100S/104S-C												
		09	12	16	23	30	37	43	55	60	72	85	97	
Coil Type:	Conventional	X	X	X	X	X	X	X	X	X	X	X	X	
	Electronic – EI	X	X	X	X	X	X	X	X	–	–	–	–	
Star-Delta Starting (50 Hz)														
Rated Operational Current, I_e	≤ 230V	[A]	21	26	35	46	61	66	76	96	107	125	147	166
	≤ 240V	[A]	21	26	35	46	61	66	76	96	107	125	47	165
	400V	[A]	16	21	28	40	52	64	74	95.3	104	125	147	168
	415V	[A]	16	21	28	40	52	64	74	95.3	104	125	47	168
	500V	[A]	12	17	24	35	43	52	66	76.2	95	116	139	135
	690V	[A]	8.6	12	16	21	31	36	43	55.4	59	73	85	99
Rated Operational Power, P_e	230V ⁽¹⁾	[kW]	5.5	7.5	10	13	17	20	22	30	32	37	45	50
	240V ⁽¹⁾	[kW]	5.5	7.5	10	13	18.5	20	22	30	32	40	50	50
	400V ⁽¹⁾	[kW]	7.5	10	13	20	25	32	40	45	55	63	80	90
	415V ⁽¹⁾	[kW]	7.5	11	15	22	25	32	40	45	55	63	80	90
	500V ⁽¹⁾	[kW]	7.5	11	15	22	25	32	45	45	63	80	90	90
	690V ⁽¹⁾	[kW]	7.5	10	13	18.5	25	32	40	45	55	63	80	90
Switching of Power Transformers, AC-6a (50 Hz)														
Inrush Current = n														
Rated transformer current														
n = 30	≤ 230V	[A]	10.9	10.9	10.9	10.9	20	20	23	23	40.8	40.8	40.8	48.5
	≤ 240V	[A]	10.9	10.9	10.9	10.9	20	20	23	23	40.8	40.8	40.8	48.5
	≤ 400V	[A]	10.9	10.9	10.9	10.9	20	20	23	23	40.8	40.8	40.8	48.5
	≤ 415V	[A]	10.9	10.9	10.9	10.9	20	20	23	23	40.8	40.8	40.8	48.5
	≤ 500V	[A]	10.9	10.9	10.9	10.9	20	20	23	23	40.8	40.8	40.8	48.5
	≤ 690V	[A]	10.9	10.9	10.9	10.9	20	20	23	23	40.8	40.8	40.8	48.5
Apparent Power	230V	[kVA]	4.3	4.3	4.3	4.3	8	8	9.2	9.2	16	16	16	19.3
	240V	[kVA]	4.5	4.5	4.5	4.5	8.3	8.3	10	10	17	17	17	20.2
	400V	[kVA]	7.5	7.5	7.5	7.5	14	14	16	16	28	28	28	33.6
	415V	[kVA]	7.8	7.8	7.8	7.8	14	14	17	17	29	29	29	34.9
	500V	[kVA]	9.4	9.4	9.4	9.4	17	17	20	20	35	35	35	42
	690V	[kVA]	13	13	13	13	24	24	27	27	49	49	49	58
n=20	≤ 690V	[A]	16.3	16.3	16.3	16.3	30	30	34.5	34.5	61.3	61.3	61.3	72.8
n=15	≤ 690V	[A]	22	22	22	22	40	40	46	46	82	82	82	97
60 Hz Peak Inrush/peak rated transformer current														
n=30		[A]	10.9	10.9	10.9	10.9	20	20	23	23	40.8	40.8	40.8	48.5
Apparent Power	200V	[kVA]	3.8	3.8	3.8	3.8	6.9	6.9	8.0	8	14.1	14.4	14.4	16.8
	208V	[kVA]	3.9	3.9	3.9	3.9	7.2	7.2	8.3	8.3	14.7	14.7	14.7	17.5
	240V	[kVA]	4.5	4.5	4.5	4.5	8.3	8.3	9.6	9.6	17.0	17.0	17.0	20.2
	480V	[kVA]	9.1	9.1	9.1	9.1	16.6	16.6	19.1	19.1	33.9	33.9	33.9	40.3
	600V	[kVA]	11.3	11.3	11.3	11.3	20.8	20.8	23.9	23.9	42.4	42.4	42.4	50.4
	660V	[kVA]	12.5	12.5	12.5	12.5	22.9	22.9	26.3	26.3	46.6	46.6	46.6	55.4
60 Hz Peak Inrush/peak rated transformer current														
n=20		[A]	16.3	16.3	16.3	16.3	30	30	34.5	34.5	61.3	61.3	61.3	72.8
Apparent Power	200V	[kVA]	5.6	5.6	5.6	5.6	10.4	10.4	12.0	12	21.2	21.2	21.2	25.2
	208V	[kVA]	5.9	5.9	5.9	5.9	10.8	10.8	12.4	12.4	22.1	22.1	22.1	26.2
	240V	[kVA]	6.8	6.8	6.8	6.8	12.5	12.5	14.3	14.3	25.5	25.5	25.5	30.3
	480V	[kVA]	13.6	13.6	13.6	13.6	24.9	24.9	28.7	28.7	51.0	51.0	51.0	60.5
	600V	[kVA]	16.9	16.9	16.9	16.9	31.2	31.2	35.9	35.9	63.7	63.7	63.7	75.7
	660V	[kVA]	18.6	18.6	18.6	18.6	34.3	34.3	39.4	39.4	70.1	70.1	70.1	83.2

(1) Power ratings at 50 Hz: Preferred values according to IEC 60072-1

Table 13 - Main Circuits

		100/104-C, 100S/104S-C											
		09	12	16	23	30	37	43	55	60	72	85	97
Coil Type:	Conventional	X	X	X	X	X	X	X	X	X	X	X	X
	Electronic – EI	X	X	X	X	X	X	X	X	X	–	–	–
60 Hz Peak Inrush/peak rated transformer current													
n=15	[A]	22	22	22	22	40	40	46	46	82	82	82	97
Apparent Power	200V [kVA]	7.5	7.5	7.5	7.5	13.9	13.9	15.9	15.9	28.4	28.4	28.4	33.6
	208V [kVA]	7.8	7.8	7.8	7.8	14.4	14.4	16.6	16.6	29.5	29.5	29.5	34.9
	240V [kVA]	9.0	9.0	9.0	9.0	16.6	16.6	19.1	19.1	34.1	34.1	34.1	40.3
	480V [kVA]	18.1	18.1	18.1	18.1	33.3	33.3	38.2	38.2	68.2	68.2	68.2	80.6
	600V [kVA]	22.6	22.6	22.6	22.6	41.6	41.6	47.8	47.8	85.2	85.2	85.2	100.8
	660V [kVA]	24.9	24.9	24.9	24.9	45.7	45.7	52.6	52.6	93.7	93.7	93.7	110.9

Table 14 - Main Circuits

		100/104-C, 100S/104S-C															
		09	12	16	23	30	37	40*200	40*400	43	55	60	72	85	90*200	90*400	97
Coil Type:	Conventional	X	X	X	X	X	X	X	X	X	X	X	X	X	X	X	X
	Electronic – EI	X	X	X	X	X	X	X	X	X	X	–	–	–	–	–	–
Switching of 3-phase Capacitors, AC-6b (50 Hz)⁽¹⁾																	
Single capacitor 40 °C (104 °F)	230V [kVAR]	8	8	8.5	9	14	14	–	–	24	24	28	28	28	–	–	28
	240V [kVAR]	8	8	8.5	9	14	14	–	–	25	25	29	29	29	–	–	29
	400V [kVAR]	8	8	10	12.5	20	24	–	–	35	35	48	48	48	–	–	48
	415V [kVAR]	8	8	10	12.5	20	25	–	–	35	35	50	50	50	–	–	50
	500V [kVAR]	8	8	10	12.5	20	25	–	–	35	35	50	55	60	–	–	60
	690V [kVAR]	8	8	10	12.5	20	25	–	–	35	35	50	55	60	–	–	60
Single capacitor 60 °C (140 °F)	230V [kVAR]	8	8	8.5	9	12.5	12.5	–	–	18	18	28	28	28	–	–	28
	240V [kVAR]	8	8	8.5	9	12.5	12.5	–	–	18	18	29	29	29	–	–	29
	400V [kVAR]	8	8	10	12.5	20	21.5	–	–	30	30	42	48	48	–	–	48
	415V [kVAR]	8	8	10	12.5	20	22	–	–	30	30	42	50	50	–	–	50
	500V [kVAR]	8	8	10	12.5	20	25	–	–	30	30	42	50	55	–	–	55
	690V [kVAR]	8	8	10	12.5	20	25	–	–	30	30	42	50	55	–	–	55
Group capacitors 40 °C (104 °F)	230V [kVAR]	5	5	8	9	12.5	14	–	–	20	20	28	28	28	–	–	28
	240V [kVAR]	5	5	8	9	12.5	14	–	–	20	20	29	29	29	–	–	29
	400V [kVAR]	5	5	8	10	15	20	–	–	25	25	40	48	48	–	–	48
	415V [kVAR]	5	5	8	10	15	20	–	–	25	25	40	50	50	–	–	50
	500V [kVAR]	5	5	8	10	15	20	–	–	25	25	40	50	50	–	–	50
	690V [kVAR]	5	5	8	10	15	20	–	–	25	25	40	50	50	–	–	50
Group capacitors 60 °C (140 °F)	230V [kVAR]	5	5	8	9	12.5	12.5	–	–	18	18	28	28	28	–	–	28
	240V [kVAR]	5	5	8	9	12.5	12.5	–	–	18	18	29	29	29	–	–	29
	400V [kVAR]	5	5	8	10	15	20	–	–	25	25	40	48	48	–	–	48
	415V [kVAR]	5	5	8	10	15	20	–	–	25	25	40	50	50	–	–	50
	500V [kVAR]	5	5	8	10	15	20	–	–	25	25	40	50	50	–	–	50
	690V [kVAR]	5	5	8	10	15	20	–	–	25	25	40	50	50	–	–	50
60 Hz Single Capacitor – 40 °C (104 °F)	200V [kVAR]	5	5	8	9	12.5	14	–	–	20	20	28	28	28	–	–	28
	230V [kVAR]	5	5	8	9	12.5	14	–	–	20	20	29	29	29	–	–	29
	460V [kVAR]	5	5	8	10	15	20	–	–	25	25	40	50	50	–	–	50
	600V [kVAR]	5	5	8	10	15	20	–	–	25	25	40	50	50	–	–	50
60 Hz Group Capacitors – 40 °C (104 °F)	200V [kVAR]	5	5	8	9	12.5	12.5	–	–	18	18	28	28	28	–	–	28
	230V [kVAR]	5	5	8	9	12.5	12.5	–	–	18	18	29	29	29	–	–	29
	460V [kVAR]	5	5	8	10	15	20	–	–	25	25	40	50	50	–	–	50
	600V [kVAR]	5	5	8	10	15	20	–	–	25	25	40	50	50	–	–	50

(1) Inductance of leads between capacitors in parallel: min. 6 µH (100-C09...C30 contactors: min 30 µH)

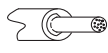
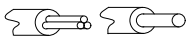

Table 15 - Main Circuits

		100/104-C, 100S/104S-C																
		09	12	16	23	30	37	40*200	40*400	43	55	60	72	85	90*200	90*400	97	
Coil Type:	Conventional	X	X	X	X	X	X	X	X	X	X	X	X	X	X	X	X	X
	Electronic – EI	X	X	X	X	X	X	X	X	X	X	X	–	–	–	–	–	–
Switching of Lamps																		
Gas discharge lamps AC-5a, 40 °C (104 °F)																		
open	[A]	22.5	25	28	29	40.5	45	65	65	77	77	81	85	90	115	115	115	
enclosed	[A]	22.5	25	28	29	37	41	54	54	57	57	77	81	90	95	95	100	
Individually compensated:																		
Max. capacitance at expected																		
Short-circuit current of	10 kA	[μF]	1000	1000	1000	1000	2700	2700	–	–	3200	3200	4000	4000	4700	–	–	4700
	20 kA	[μF]	500	500	500	500	1350	1350	–	–	1600	1600	2000	2000	2350	–	–	2350
	50 kA	[μF]	200	200	200	200	540	540	–	–	640	640	800	800	940	–	–	940
Filament AC-5b	230/240V	[A]	12	16	18	22	30	37	18	25	43	51	60	70	76	60	75	90
Switching of Low Inductive Loads in Home Appliances and Similar Applications per IEC 61095 (50 Hz)																		
AC-7a	230V	[A]	32	32	32	32	45	45	–	–	63	63	–	–	–	–	–	–
	400V	[A]	32	32	32	32	45	45	–	–	63	63	–	–	–	–	–	–
	440V	[A]	32	32	32	32	45	45	–	–	63	63	–	–	–	–	–	–
Switching of Motor Load for Home Appliances (50 Hz)																		
AC-7b	230V	[A]	10.5	14	19	23	30	–	–	–	–	–	–	–	–	–	–	–
	400V	[A]	9	12	16	20	30	–	–	–	–	–	–	–	–	–	–	–
	440V	[A]	7.5	10	13.5	18	27	–	–	–	–	–	–	–	–	–	–	–
Switching of Hermetically Sealed Cooling Compressor Motors - manual reset of overload release (50 Hz)																		
AC-8a	400V	[A]	12	16	22	32	38	45	–	–	63	63	72	85	100	–	–	115
	500V	[A]	12	16	22	32	38	45	–	–	63	63	72	85	100	–	–	115
	690V	[A]	8	10	14	20	28	35	–	–	42	42	56	67	80	–	–	90
- automatic reset of overload release																		
AC-8b	400V	[A]	5.5	7	9.3	12	13	14	–	–	16	16	24	30	35	–	–	35
	500V	[A]	5.5	7	9.3	12	13	14	–	–	16	16	24	30	35	–	–	35
	690V	[A]	5.5	7	9.3	12	13	14	–	–	16	16	24	30	35	–	–	35
Switching of DC Loads																		
Non-inductive or slightly inductive loads or resistance furnaces DC-1, 60 °C (140 °F)																		
1 pole	24V	[A]	25	25	32	32	45	45	45	45	50	50	70	80	80	80	80	80
	48/60V	[A]	20	20	20	20	25	25	25	25	30	30	40	40	40	40	40	40
	110V	[A]	6	6	6	6	8	8	10	10	9	9	11	11	11	11	11	11
	220V	[A]	1.5	1.5	1.5	1.5	1.5	1.5	1.5	1.5	1.5	1.5	2	2	2	1.8	1.8	2
	440V	[A]	0.4	0.4	0.4	0.4	0.4	0.4	0.4	0.4	0.5	0.5	0.5	0.5	0.5	0.5	0.5	0.5
2 poles in series	24V	[A]	25	25	32	32	45	45	45	45	50	50	70	80	80	80	80	80
	48/60V	[A]	25	25	32	32	45	45	45	45	50	50	70	80	80	80	80	80
	110V	[A]	25	25	32	32	45	45	45	45	50	50	70	80	80	80	80	80
	220V	[A]	8	8	8	10	10	10	10	10	10	10	15	15	15	15	15	15
	440V	[A]	1	1	1	1	1	1	1	1	1	1	1.5	1.5	1.5	1.5	1.5	1.5
3 poles in series	24V	[A]	25	25	32	32	45	45	–	45	63	63	90	90	100	–	100	100
	48/60V	[A]	25	25	32	32	45	45	–	45	63	63	90	90	100	–	100	100
	110V	[A]	25	25	32	32	45	45	–	45	63	63	90	90	100	–	100	100
	220V	[A]	25	25	32	32	45	45	–	45	50	50	70	80	80	–	80	80
	440V	[A]	3	3	3	3	3.5	3.5	–	3.5	4	4	5	5	5	–	5	5

Table 16 - Main Circuits

		100/104-C, 100S/104S-C																
		09	12	16	23	30	37	40*200	40*400	43	55	60	72	85	90*200	90*400	97	
Coil Type:	Conventional	X	X	X	X	X	X	X	X	X	X	X	X	X	X	X	X	
	Electronic – EI	X	X	X	X	X	X	X	X	X	X	X	–	–	–	–	–	
Switching of DC Loads, Continued																		
Shunt-wound Motors, Starting, reverse current braking, reversing, stepping DC-3, 60 °C (140 °F)																		
3 poles in series	24V	[A]	25	25	32	32	45	45	–	–	63	63	90	90	100	–	–	100
	48/60V	[A]	25	25	32	32	45	45	–	–	50	50	70	70	80	–	–	80
	110V	[A]	20	20	25	25	30	30	–	–	35	35	70	70	80	–	–	80
	220V	[A]	6	6	6	10	15	15	–	–	20	20	25	25	30	–	–	30
	440V	[A]	0.6	0.6	0.6	0.6	0.6	0.6	–	–	0.6	0.6	0.6	0.6	0.6	–	–	0.6
Series-wound Motors, Starting, reverse current braking, reversing, stepping DC-5, 60 °C (140 °F)																		
3 poles in series	24V	[A]	25	25	32	32	45	45	–	–	63	63	90	90	100	–	–	100
	48/60V	[A]	25	25	32	32	45	45	–	–	50	50	70	70	80	–	–	80
	110V	[A]	20	20	25	25	30	30	–	–	35	35	70	70	80	–	–	80
	220V	[A]	6	6	6	10	15	15	–	–	20	20	25	25	30	–	–	30
	440V	[A]	0.6	0.6	0.6	0.6	0.6	0.6	–	–	0.6	0.6	0.6	0.6	0.6	–	–	0.6
Short Time Withstand I_{CW}, 60 °C (140 °F)																		
3- and 4-pole	10 s	[A]	170	170	170	215	300	304	304	304	375	375	700	700	700	700	700	840
Resistance and Power Dissipation																		
Main current circuit resistance	[mΩ]	2.7	2.7	2.7	2	2	2	2	1.5	1.5	1	0.9	0.9	0.9	0.8	0.7	0.6	
Power dissipation by all circuits at I_e AC-3/400V	[W]	0.66	1.2	2.1	3.2	5.4	8.2	11.3	8.4	8.3	9.1	9.7	14	19.5	11.6	20.2	17	
Total power dissipation At I_e AC-3/400V	AC control	[W]	3.4	3.9	4.8	6.3	8.5	11.3	8.8	9.5	11.6	12.4	14.2	18.5	24	20.6	29.2	26
	DC control (conv.)	[W]	–	–	–	–	–	–	–	–	–	–	13.7	18	23.5	16.6	25.2	22
	DC control (elect.)	[W]	2.4	2.9	3.8	4.9	7.1	9.9	8	8.7	10.8	11.6	–	–	–	–	–	–
Lifespan																		
Mechanical AC control	[Million ops.]	13	13	13	13	13	13	10	10	12	12	6	6	6	6	6	6	
Mechanical DC control	[Million ops.]	13	13	13	13	13	13	10	10	13	13	6	6	6	6	6	6	
Electrical AC-3 (400 V)	[Million ops.]	1.3	1.3	1.3	1.3	1.3	1.3	–	–	1	0.8	1	1	1	–	–	1	
Weight																		
AC	Non-Rev.	[kg (lbs)]	0.39 (0.86)	0.39 (0.86)	0.39 (0.86)	0.39 (0.86)	0.48 (1.06)	0.49 (1.08)	0.63 (1.39)	0.63 (1.39)	0.51 (1.12)	0.51 (1.12)	1.45 (3.20)	1.45 (3.20)	1.45 (3.20)	–	–	1.45 (3.20)
	Rev.	[kg (lbs)]	0.85 (1.89)	0.85 (1.89)	0.85 (1.89)	0.85 (1.89)	1.08 (2.39)	1.08 (2.39)	–	–	1.15 (2.54)	1.15 (2.54)	3.14 (6.92)	3.14 (6.92)	3.14 (6.92)	–	–	3.14 (6.92)
DC	Non-Rev.	[kg (lbs)]	0.6 (1.32)	–	–	–	–	–	–	–	–	1.47 (3.24)	1.47 (3.24)	1.47 (3.24)	–	–	1.47 (3.24)	
	Rev.	[kg (lbs)]	1.27 (2.81)	–	–	–	–	–	–	–	–	–	3.22 (7.1)	3.22 (7.1)	3.22 (7.1)	–	–	3.22 (7.1)
DC (Electronic-E0, EJ)	Non-Rev.	[kg (lbs)]	0.40 (0.88)	0.40 (0.88)	0.40 (0.88)	0.40 (0.88)	0.40 (0.88)	0.49 (1.08)	0.49 (1.08)	0.57 (1.25)	0.57 (1.25)	0.57 (1.25)	–	–	–	–	–	–
	Rev.	[kg (lbs)]	0.87 (1.91)	0.87 (1.91)	0.87 (1.91)	0.87 (1.91)	0.87 (1.91)	1.08 (2.39)	1.08 (2.39)	–	1.27 (2.79)	1.27 (2.79)	–	–	–	–	–	–
DC (Electronic- EW, EY, ED, EA)	Non-Rev.	[kg (lbs)]	0.43 (0.95)	0.43 (0.95)	0.43 (0.95)	0.43 (0.95)	0.43 (0.95)	0.52 (1.14)	0.52 (1.14)	0.60 (1.32)	0.60 (1.32)	0.60 (1.32)	–	–	–	–	–	–
	Rev.	[kg (lbs)]	0.93 (2.05)	0.93 (2.05)	0.93 (2.05)	0.93 (2.05)	0.93 (2.05)	1.14 (2.51)	1.14 (2.51)	–	1.33 (2.93)	1.33 (2.93)	–	–	–	–	–	–

Table 17 - Conductors

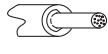
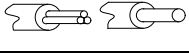
			100/104-C, 100S/104S-C														
			09	12	16	23	30	37	40	43	55	60	72	85	90	97	
Coil Type:	Conventional		X	X	X	X	X	X	X	X	X	X	X	X	X		
	Electronic – EI		X	X	X	X	X	X	X	X	X	–	–	–	–		
Conductor Cross Sections - Main Contacts Terminal type			 (1)														
	1 conductor	[mm ²]				1...4			2.5...10			2.5...16			2.5...35		
	2 conductors	[mm ²]	1...4			2.5...10			2.5...10			2.5...25					
	1 conductor	[mm ²]	1.5...6			2.5...16			2.5...25			2.5...50					
	2 conductors	[mm ²]	1.5...6			2.5...16			2.5...16			2.5...35					
Recommended torque		[N•m]	1.5...2.0			2.5...3.5			2.5...3.5			4.5...6					
Cross section per UL/CSA		[AWG]	16...10			14...4			14...6	14...4		14...1					
Recommended torque		[lb•in]	13.3...17.7			22...31			22...31			40...53					
Conductor Cross Sections - Coil Terminal type			 (1)														
	1 conductor	[mm ²]							1...2.5								
	2 conductors	[mm ²]							1...2.5								
	1 conductor	[mm ²]							1...4								
	2 conductors	[mm ²]							1...4								
Recommended torque		[N•m]							1...1.5								
Cross section per UL/CSA		[AWG]							16...12								
Recommended torque		[lb•in]							9...13								

(1) Pozidriv No. 2 / Blade No. 3 screw
 (2) Pozidriv No. 2 / Blade No. 4 screw
 (3) Hexagonal socket screw

Table 18 - Short-Circuit Coordination Data⁽¹⁾

		100/104-C, 100S/104S-C																
		09	12	16	23	30	37	40*200	40*400	43	55	60	72	85	90*200	90*400	97	
Coil Type:	Conventional	X	X	X	X	X	X	X	X	X	X	X	X	X	X	X	X	
	Electronic - EI	X	X	X	X	X	X	X	X	X	X	-	-	-	-	-	-	
Short Circuit Coordination (Max. Fuse or Circuit Breaker Rating) Per IEC 60947-4-1 (contactor and fuses only)																		
DIN Fuses- gG, gL	Type"1"(690V)	[A]	50 kA Available Fault Current															
	Type"2"(400V)	[A]	50	50	50	80	125	125	160	160	160	160	250	250	250	250	250	250
	Type"2"(690V)	[A]	25	35	35	40	80	80	63	80	100	100	160	160	160	160	100	200
BS88Fuses	Type"1"(415V)	[A]	65kA Available Fault Current															
	Type"2"(415V)	[A]	25	32	40	50	63	80	-	-	80	TBD	100	160	160	-	-	TBD
	Type"2"(415V)	[A]	20	25	32	50	63	80	-	-	80	TBD	100	125	160	-	-	TBD
Per UL 508 and CSA 22.2 No. 14 (contactor and fuses or circuit breaker only)																		
UL Class K5 and RK5 Fuses	UL Listed Combination (600V)	[A]	5 kA Available Fault Current															
		[A]	35	40	70	90	110	125	125	125	150	200	200	-	-	-	-	-
UL Class CC and CSA HRCl-MISC Fuses	UL verified combination to IEC60947-4-1 "Type2"	[A]	10 kA Available Fault Current															
		[A]	-	-	-	-	-	-	-	-	-	-	-	250	300	300	300	350
UL Class J and CSA HRCl-J Fuses	UL verified combination to IEC60947-4-1 "Type 2"	[A]	100 kA Available Fault Current															
		[A]	20 ⁽²⁾	20	30	40	-	-	-	-	-	-	-	-	-	-	-	-
UL Inverse-time Circuit Breaker	UL Listed Combination (480V)	[A]	5 kA Available Fault Current															
		[A]	30	30	50	50	125	125	-	-	125	150	250	-	-	-	-	-
	UL Listed Combination (600V)	[A]	10 kA Available Fault Current															
		[A]	-	-	-	-	-	-	-	-	-	-	-	250	250	-	-	250
	UL Listed Combination (600V)	[A]	18 kA Available Fault Current															
		[A]	-	-	-	-	-	-	-	-	-	-	-	-	-	-	-	-
	UL Listed Combination (600V)	[A]	25 kA Available Fault Current															
		[A]	30 ⁽³⁾	30 ⁽³⁾	30 ⁽³⁾	30 ⁽³⁾	50 ⁽⁴⁾	50 ⁽⁴⁾	-	-	50 ⁽⁴⁾	-	110	110	110	-	-	-
	UL Listed Combination (480V)	[A]	50 kA Available Fault Current															
		[A]	-	-	-	-	50 ⁽⁴⁾	50 ⁽⁴⁾	-	-	50 ⁽⁴⁾	-	-	-	-	-	-	-
UL Listed Combination (480V/277V)	[A]	65 kA Available Fault Current																
	[A]	30 ⁽³⁾	30 ⁽³⁾	30 ⁽³⁾	30 ⁽³⁾	-	-	-	-	-	-	-	-	-	-	-	-	
UL Listed Combination (480V)	[A]	50 kA Available Fault Current																
	[A]	-	-	-	-	100 ⁽⁵⁾	100 ⁽⁵⁾	-	-	100 ⁽⁵⁾	125	200 ⁽⁵⁾	225 ⁽⁵⁾	225 ⁽⁵⁾	-	-	225 ⁽⁵⁾	

(1) See the Rockwell Automation Global SCCR Tool at rok.auto/sccr for complete short-circuit current ratings.
 (2) 15 A max. fuse for Type 2 coordination.
 (3) Ratings apply when used with Bulletin 140U-D circuit breakers only.
 (4) Minimum enclosure size 12-3/8 x 7-5/8 s 7-1/4 inches
 (5) Minimum enclosure size 20 x 12 x 8 inches with two latches.

Table 19 - Coil Data

			100/104-C, 100S/104S-C														
			09	12	16	23	30	37	40*200	40*400	43	55	60	72	85	90*200	90*400
Coil Type:	Conventional		X	X	X	X	X	X	X	X	X	X	X	X	X	X	X
	Electronic - EI		X	X	X	X	X	X	X	X	X	-	-	-	-	-	-
Operating Limits																	
50 Hz, 60 Hz, 50/60 Hz	pick-up	[x U _s]	0.85...1.1					0.85...1.1					0.85...1.1				
	dropout	[x U _s]	0.3...0.6					0.3...0.6					0.3...0.6				
DC (conventional)	pick-up	[x U _s]	-					-					0.8...1.1				
	dropout	[x U _s]	-					-					0.1...0.6				
DC (electronic—EQ, EJ, EW)	pick-up	[x U _s]	0.7...1.25										-				
	dropout	[x U _s]	0.3...0.4										-				
DC (electronic—EY)	pick-up	[x U _s]	0.8...1.25										-				
	dropout	[x U _s]	0.3...0.4										-				
DC (electronic—ED)	pick-up	[x U _s]	0.7...1.12										-				
	dropout	[x U _s]	0.3...0.4										-				
DC (electronic—EA)	pick-up	[x U _s]	0.8...1.1										-				
	dropout	[x U _s]	0.3...0.4										-				
Coil Consumption																	
50 Hz, 60 Hz, 50/60 Hz	pick-up	[VA]	75	105			135			235			400				
	hold-in	[VA/W]	9.5/2.7	12.3/3.1			13.3/3.3			19.6/5			24/9				
DC (conventional)	pick-up	[W]	-	-			-			200			325				
	hold-in	[W]	-	-			-			4			5				
DC (electronic—EQ, EJ)	pick-up (avg/peak)	[W]	10/17					16/25					-				
	hold-in	[W]	1.7					2.5					-				
DC (electronic—EY, EW)	pick-up (avg/peak)	[W]	10/17					16/25					-				
	hold-in	[W]	1.9					2.7					-				
DC (electronic—ED)	pick-up (avg/peak)	[W]	12/19					16/26					-				
	hold-in	[W]	2.1					2.8					-				
DC (electronic—EA)	pick-up (avg/peak)	[W]	14/22					18/29					-				
	hold-in	[W]	3.0					4.0					-				
Operating Times																	
AC	closing delay	[ms]	15...30	15...30	15...30	15...30					20...40			20...40			
	opening delay	[ms]	10...60	10...60	10...60	10...60					10...60			20...40			
With RC module	closing delay	[ms]	10...60	10...60	10...60	10...60			10...60	10...60			20...40				
DC (conventional)	opening delay	[ms]	-	-	-	-					50...80	20...40		15...25	20...25	20...25	
	closing delay	[ms]	-	-	-	-					7...15	20...40		15...25	20...25	20...25	
With integrated diode	opening delay	[ms]	-	-	-	-					17...23	≤ 220V 20...35			≤ 220V 20...35		
With external diode	opening delay	[ms]	-	-	-	-	-	80...125			-			-			
DC (electronic—EQ, EJ)	closing delay	[ms]	20...50					-					-				
	opening delay	[ms]	20...50					-					-				
	Max. Ripple		±15%					-					-				
	min. OFF time	[ms]	50					-					-				
DC (electronic—EW, EY, ED, EA)	closing delay	[ms]	20...50					-					-				
	opening delay	[ms]	23...33					-					-				
	Max. Ripple		±15%					-					-				
	min. OFF time	[ms]	50					-					-				

Table 20 - Auxiliary Contacts, Auxiliary Contact Blocks, and Pneumatic Timers

			Internal	Front mounted	Front mounted (Bifurcated)	Side-mounted
Switching of AC Loads						
AC-12 I_{th}	at 40 °C (104 °F)	[A]	20	10	10	10
	at 60 °C (140 °F)	[A]	20	6	6	6
AC-15 at rated voltage of	24V	[A]	10	6	3	6
	42/48V	[A]	10	6	3	6
	120V	[A]	10	6	3	6
	230V	[A]	10	5.5	3	5.5
	240V	[A]	10	5	3	5
	400V	[A]	6	3	2	3
	415V	[A]	6	3	2	3
	500V	[A]	2.5	1.6	1.2	1.6
690V	[A]	1	1	0.7	1	
Switching of DC Loads						
DC-12 L/R < 1 ms resistive loads at	24V DC	[A]	12	12	6	6
	48V DC	[A]	9	9	3.2	3.2
	110V DC	[A]	3.5	3.5	1	1
	220V DC	[A]	0.55	0.55	0.5	0.5
	440V DC	[A]	0.2	0.2	0.2	0.2
DC-14L/R <15 ms inductive loads with economy resistor in series at	24V DC	[A]	9	9	2	2
	48V DC	[A]	5	5	1.6	1.6
	110V DC	[A]	2	2	0.3	0.3
	220V DC	[A]	0.4	0.4	0.12	0.12
	440V DC	[A]	0.16	0.16	0.05	0.05
DC-13 switching electromagnets at	24V DC	[A]	5	5	2.5	5
	48V DC	[A]	3	3	1.5	2.5
	110V DC	[A]	1.2	1.2	0.6	0.68
	220V DC	[A]	0.6	0.6	0.3	0.32
	440V DC	[A]	0.3	0.15	0.15	0.15
Fuse gG						
Short-circuit protection with no welding of contacts per IEC 60947-5-1		[A]	20	10	10	10
		[A]	20	10	10	10
Protective Separation per IEC 60947-1, Annex N			between load and auxiliary circuit 320V	between load and auxiliary circuit 440V		
Min. switching capacity according to IEC 60947-5-4			17V/10mA	17V/5mA	5V/3mA	17V/10mA
Load Carrying Capacity per UL/CSA						
Rated voltage	AC	[V]	max.600			
Continuous rating	40 °C (104 °F)	[A]	10	10	10	10
Switching capacity	AC	[A]	A600			
Rated voltage	DC	[V]	max.600			
Switching capacity	DC	[A]	P600	Ø600	Ø600	

Table 21 - General Specifications

Attribute		Value
Rated Isolation Voltage U_i		
IEC	[V]	690
UL, CSA	[V]	600
Rated Impulse Voltage Withstand U _{imp}	[kV]	6
Rated Voltage U_e		
AC 50/60 Hz	[V]	115, 200, 230, 240, 400, 415, 460, 500, 575, 690
DC	[V]	24, 48, 110, 220, 440
Insulation Class of the Coil		Class F per IEC 60085, UL Class 105
Rated coil frequency		AC 50/60Hz, DC
Ambient Temperature		
Storage	[°C (°F)]	-55...+80 (-67...176)
Operation at rated voltage	[°C (°F)]	-40...+60 (-40...140)
at 70 °C (158 °F)		15% current reduction against 60 °C (140 °F) values
Climatic Withstand		IEC 60068-2-1/-2/-30
Max. Altitude of Installation Site	[m]	2000 NN, per IEC60947-1
Protection Class		100-C09...C23: IP2X from all directions 100-C30...C55: IP2X from front with front (upper) terminal wired 100-C60...C97: IP2X from front with front (upper) terminal wired (min. wire size 16 mm ² or #6 AWG)
Single contactor cover		—
Contactor with frame terminal block		—
Auxiliary contact		IP2X
Protection against Accidental Contact		Finger- and back-of-hand proof per VDE0106, part100
Resistance to Shock		IEC60068-2-27
Resistance to Vibration		IEC60068-2-6
Mechanically Linked Contacts IEC60947-5-1,Annex L		100-/100S-C09...C55+100-FA/-FB/-FC, (except L11, L22),100-/100S-C09...C55+ 100-FAB/-FBB/-FCB
Mirror Contacts IEC60947-4-1, Annex F		100-/100S-C09...C97+100-FA/-FB/-FC, (except L11, L22),100-/100S-C09...C97+ 100-SA/SB, 100-/100S-C09...C97+100-FAB/-FBB/-FCB

Table 22 - Standards Compliance and Certifications

Standards Compliance	Certifications
100-C IEC Contactors	
EN/IEC 60947-4-1, 60947-5-1	CE Marked
IEC 60947 Type "2" Coordination	CCC
CSA 22.2. No. 14	cULus Listed (File No. E3125; Guide NLDX, NLDX7)
UL 508	
Meets the material restrictions for European Directive 2002/95/IEC-EU-RoHS	

Standards Compliance	Certifications
100S-C IEC Safety Contactors	
EN50205	CE Marked
CSA C22.2 No. 14	SUVA Third-Party Certified
UL 508	cULus Listed (File No. E3125; Guide NLDX, NLDX7)
EN/IEC 60947-4	
IEC 60947-4-1 Annex F – Mirror Contacts	
IEC 60947-5-1 Annex L – Mechanically Linked Contacts	
Meets the material restrictions for European Directive 2002/95/IEC-EU-RoHS	

Life-Load Curves

Bulletin 100-C/104-C IEC contactors are designed for superior performance in a wide variety of applications. When selecting IEC products, the user must give consideration to the specific load, utilization category, and required electrical life of the application. The life-load curves shown here are based on Rockwell Automation tests according to the requirements defined in IEC 60947-4-1. Since contact life in application is dependent on environmental conditions and duty cycle, actual application contact life may vary from that indicated by the curves shown here.

To find the estimated electrical life of the contactor, follow these guidelines:

1. Identify the appropriate utilization category from [Table 23](#).
2. Choose the graph for the utilization category selected.
3. Locate the intersection of the life-load curve for the appropriate contactor with the application's operational current (I_e) found on the horizontal axis.
4. Read the estimated contact life along the vertical axis.

Contact Life for Mixed Utilization Categories AC-3 and AC-4:

In many applications, the utilization category cannot be defined as either purely AC-3 or AC-4. In those applications, the electrical life of the contactor can be estimated from the following equation:

$$L_{\text{mixed}} = L_{\text{ac3}} / [1 + P_{\text{ac4}} * (L_{\text{ac3}} / L_{\text{ac4}} - 1)], \text{ where:}$$

L_{mixed} = Approximate contact life in operations for a mixed AC-3/AC-4 utilization category application

L_{ac3} = Approximate contact life in operations for a pure AC-3 utilization category (from the AC-3 life-load curves)

L_{ac4} = Approximate contact life in operations for a pure AC-4 utilization category (from the AC-4 life-load curves)

P_{ac4} = Percentage of AC-4 operations

Table 23 - Utilization Category Determination

Test Conditions		Making			Breaking			
		I/I_e	U/U_e	$\cos \phi$	I_c/I_e	U_r/U_e	$\cos \phi$	
AC-1	Resistance Furnaces: Non inductive or slightly inductive loads	1	1	0.95	1	1	0.95	
AC-2	Slip-ring motors: Starting and reversing	2.5	1	0.65	2.5	1	0.65	
AC-3	Squirrel-cage motors: Starting and stopping of running motors	$I_e < 17 \text{ A}$	6	1	0.65	1	0.17	0.65
		$I_e > 17 \text{ A}$	6	1	0.35	1	0.17	0.35
AC-4	Squirrel-cage motors: Starting, plugging ⁽¹⁾ , inching ⁽²⁾	$I_e < 17 \text{ A}$	6	1	0.65	6	1	0.65
		$I_e > 17 \text{ A}$	6	1	0.35	6	1	0.35
AC-15	Solenoids: Contactors, valves and lifting magnets	10	1	0.7	1	1	0.4	

(1) Plugging is understood as stopping or reversing the motor rapidly by reversing motor primary connections while the motor is running.

(2) Inching (jogging) is understood as energizing a motor once or repeatedly for short periods to obtain small movements of the driven mechanism.

- I_e Rated operational current
- I_c Breaking Current
- U_e Rated voltage
- I Making Current
- U Off-load voltage
- U_r Recovery voltage

Figure 11 - AC-1, 40 °C (104 °F) Non- or slightly inductive loads, resistance furnaces; $U_e = 230...690V$

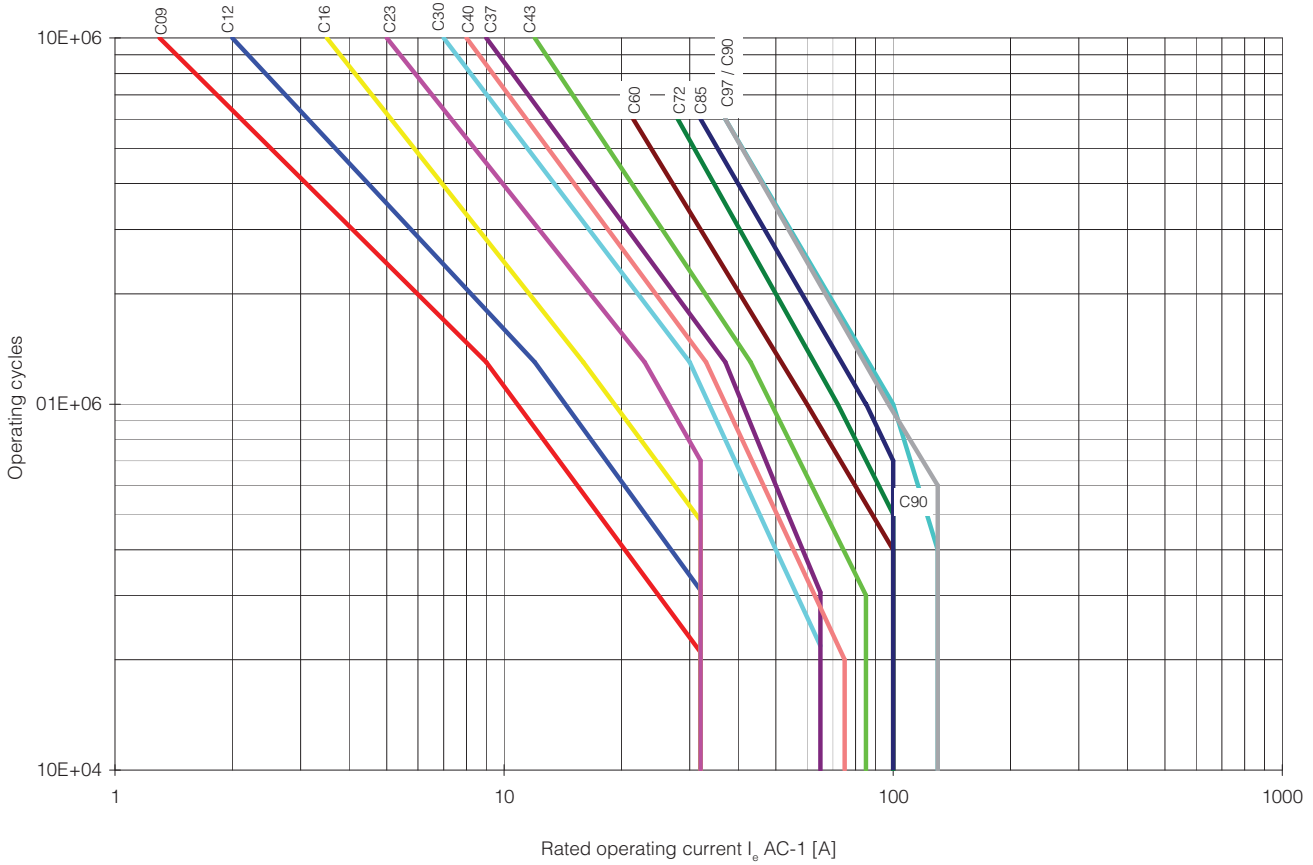

Figure 12 - AC-2, Switching of slip-ring motors; $U_e = 230...400...460V$

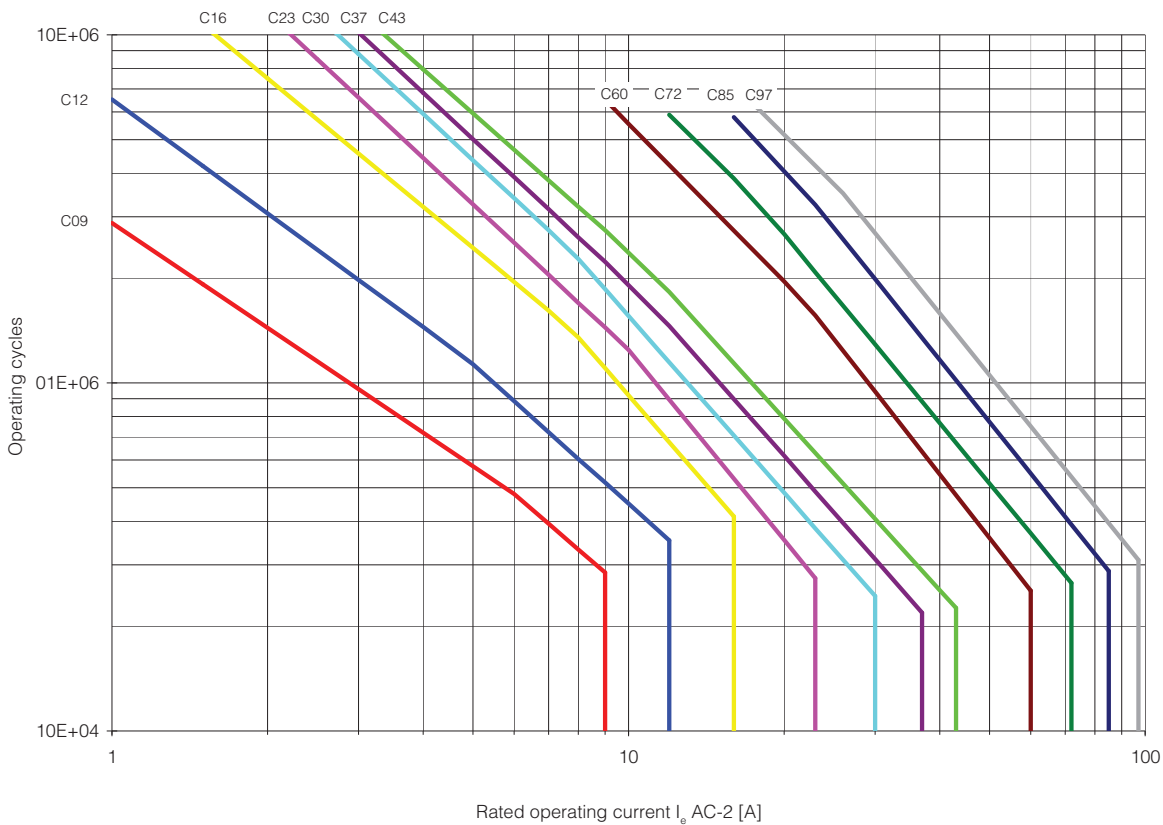

Figure 13 - AC-3, Switching of squirrel-cage motors while starting; $U_e = 230...400...460V$

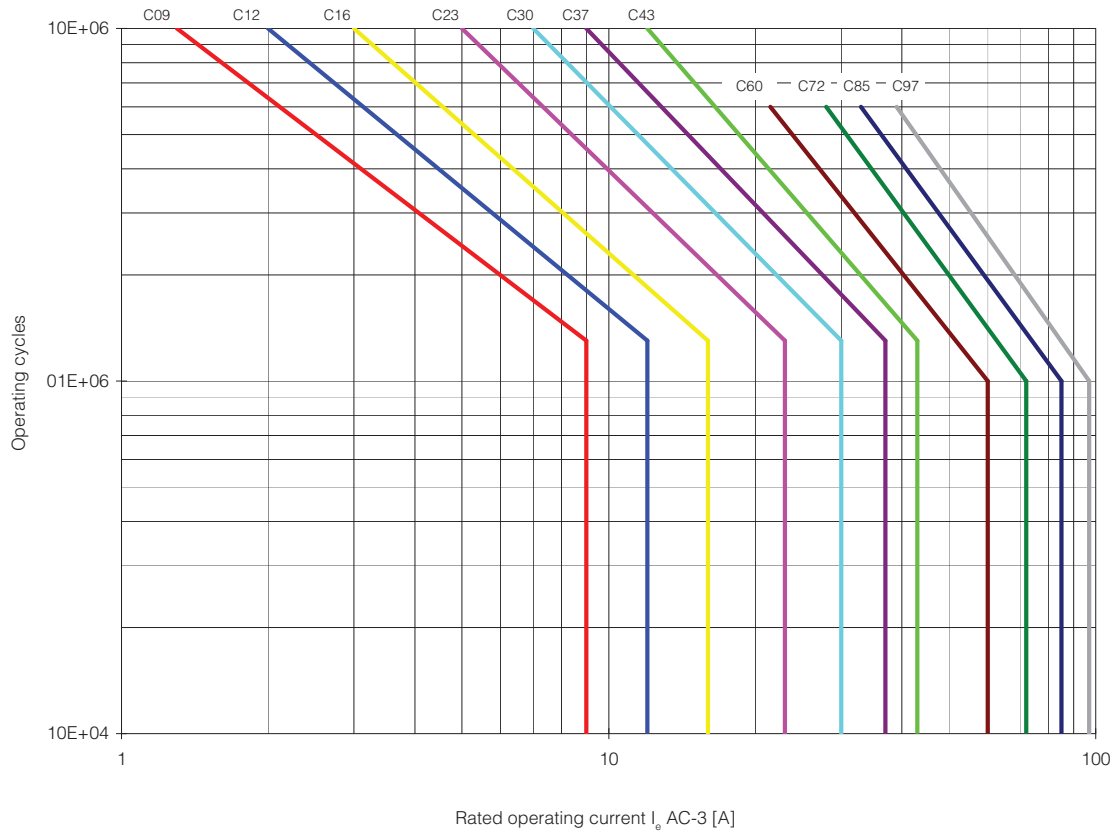

Figure 14 - AC-3, Switching of squirrel-cage motors while starting; $U_e = 500...575V$

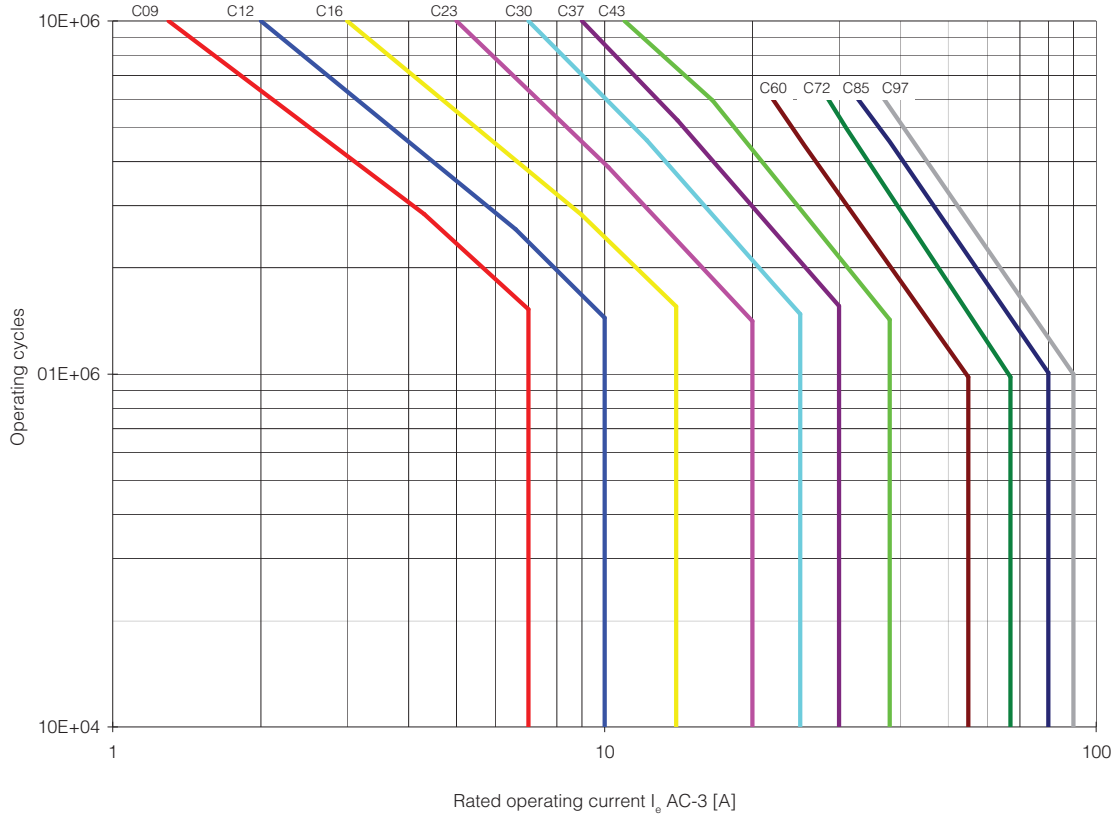

Figure 15 - AC-3, Switching of squirrel-cage motors while starting; $U_e = 690V$

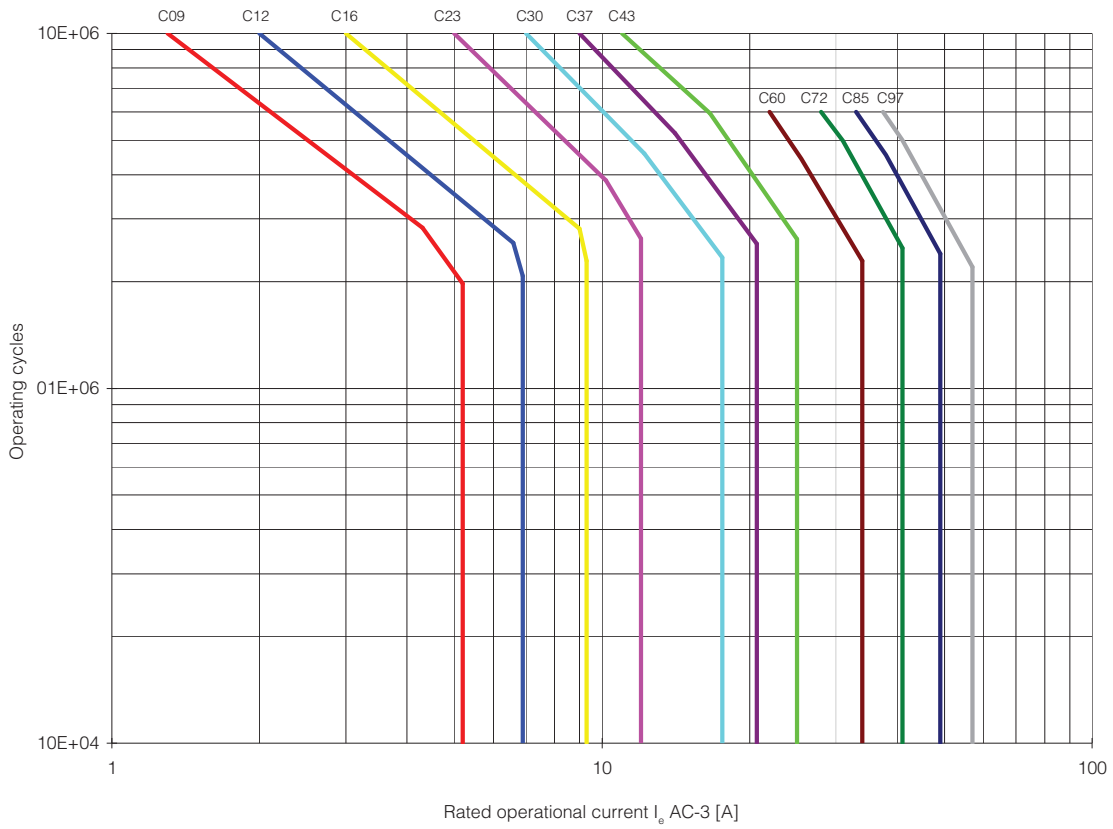

Figure 16 - AC-4, Switching of squirrel-cage motors; $U_e = 230...690V$

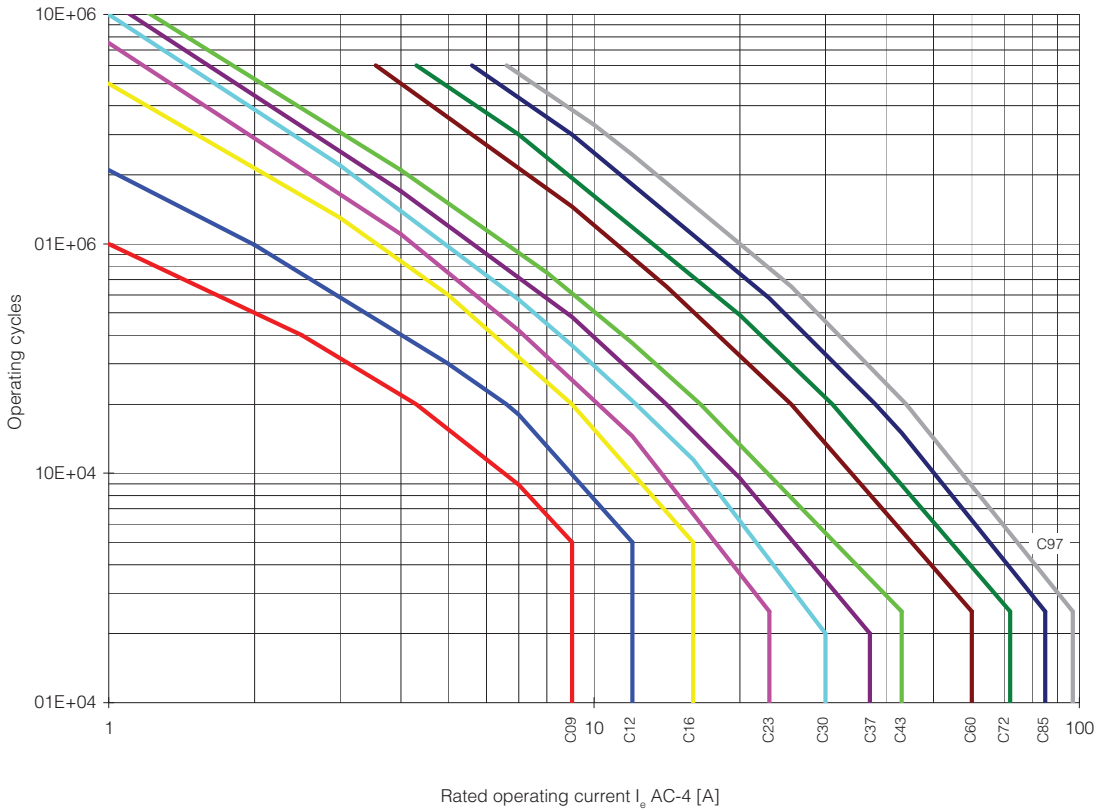

Figure 17 - AC-3 & AC-4, 10% AC-4 Mixed operation of squirrel-cage motors; $U_e = 230...400...460V$

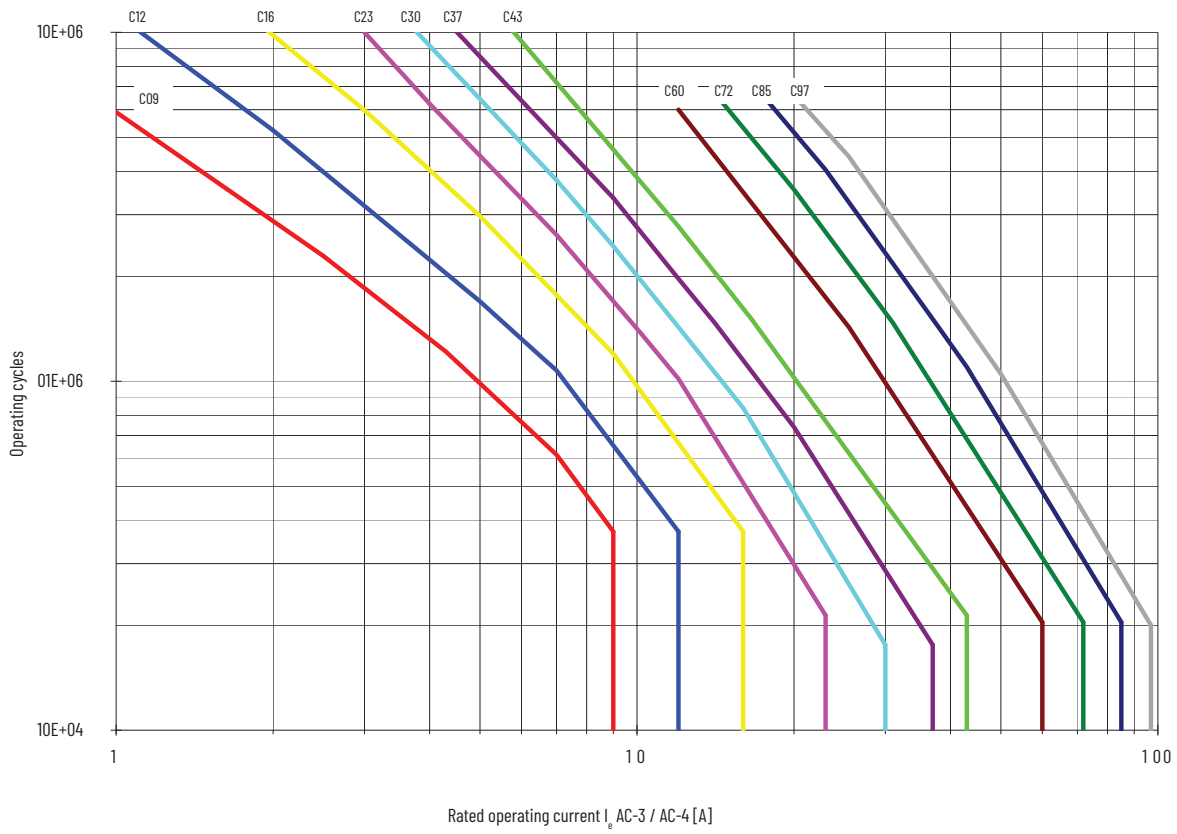
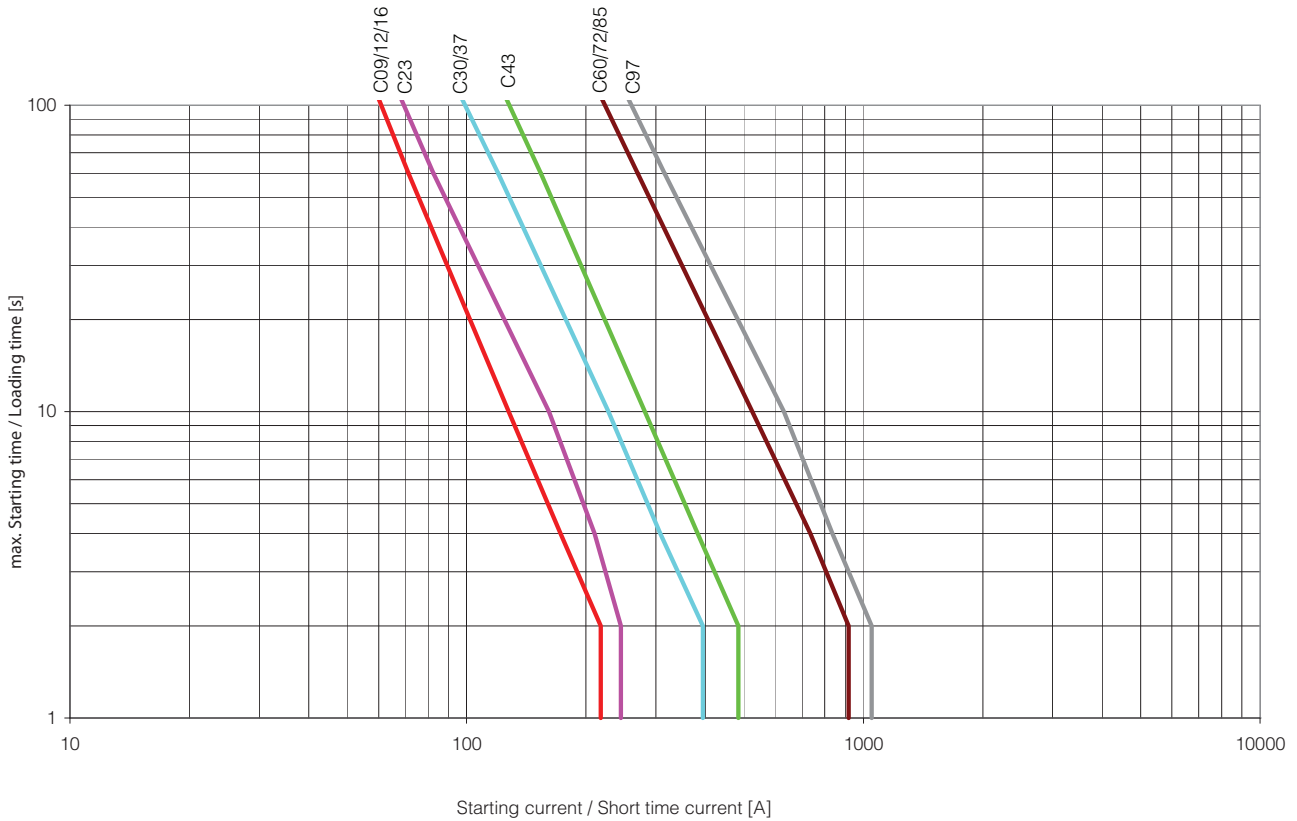

Figure 18 - Heavy Duty Starting and Regular Short-time Operation



Maximum Operating Rates

Figure 19 - AC-1, 40 °C (104 °F) Non- or slightly inductive loads, resistance furnaces; $U_e = 230...690V$

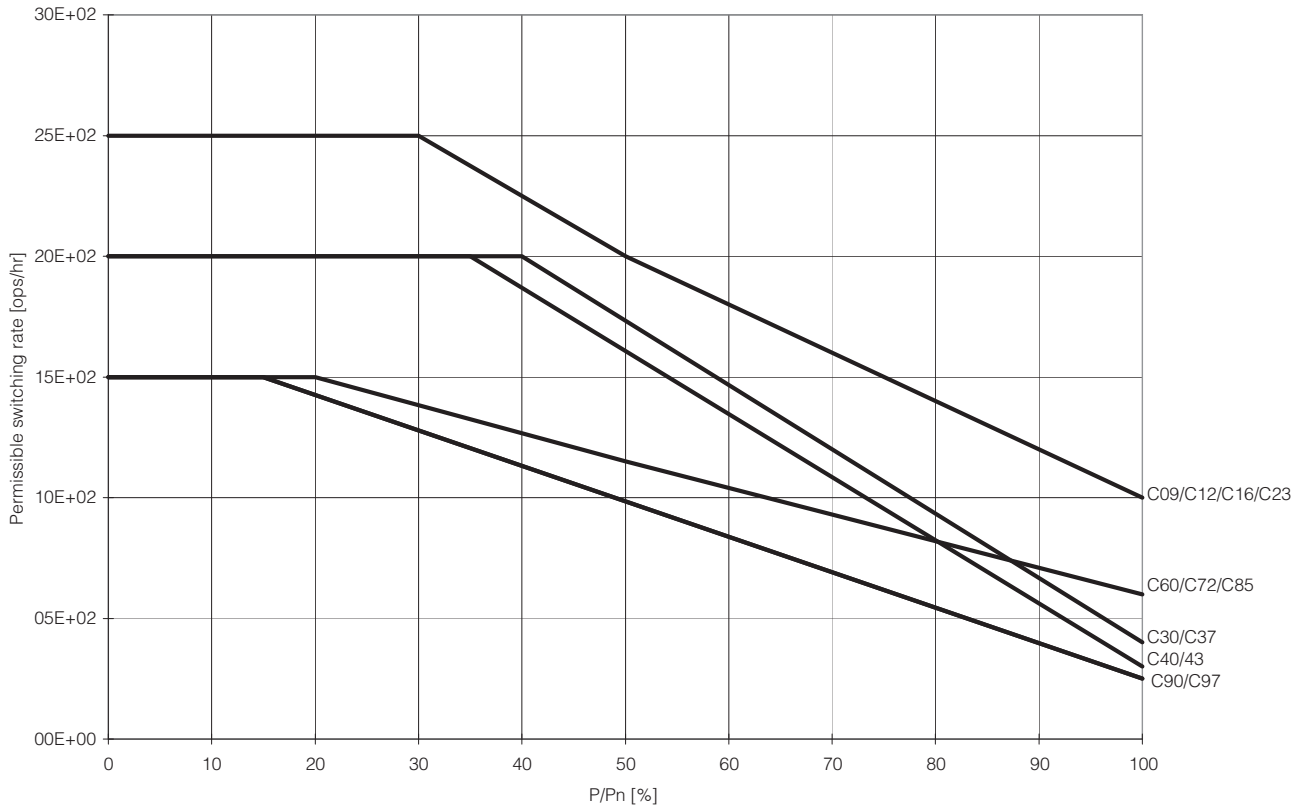
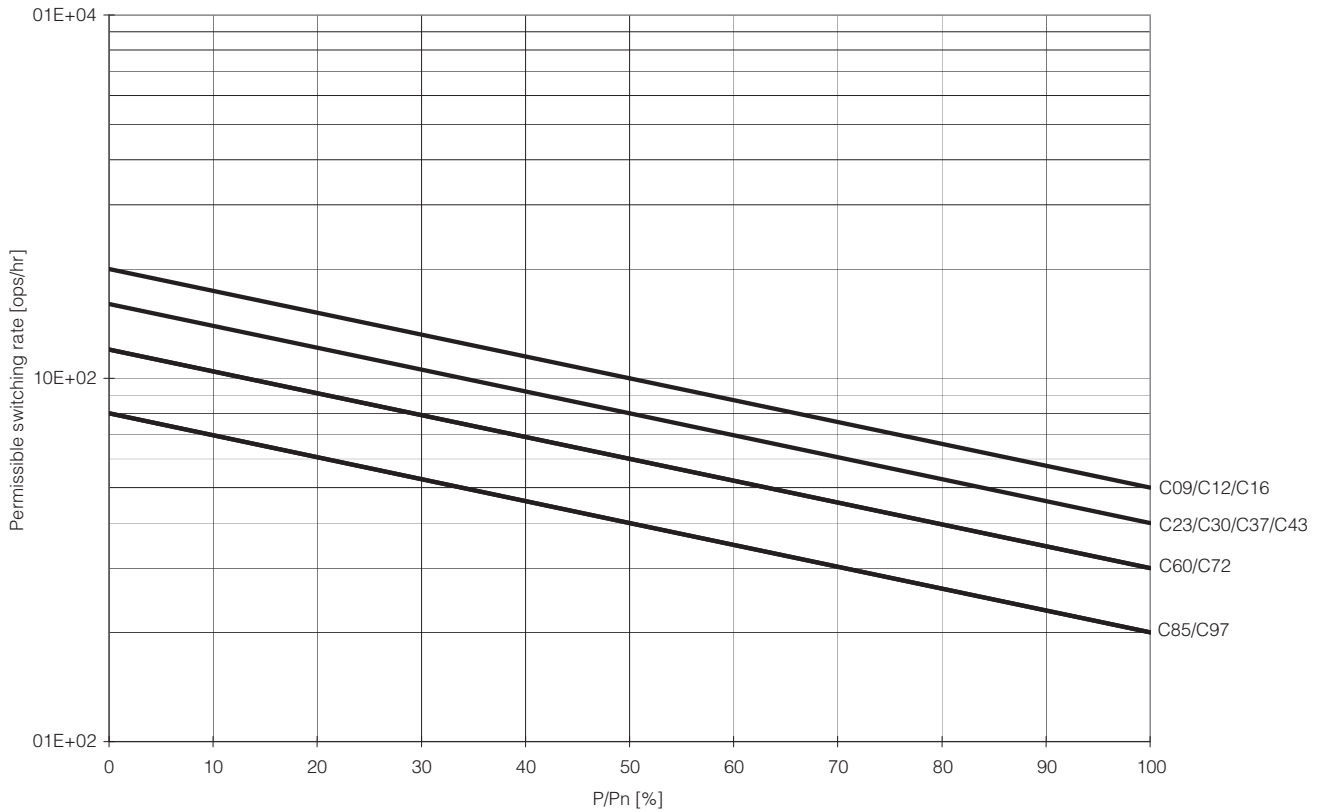

Figure 20 - AC-2, Stepping of slip-ring motors; $U_e = 230...460V$



**Figure 21 - AC-3, Switching of squirrel-cage motors while starting; $U_e = 230...460V$;
Relative operating time 40%, Starting time $t_A = 0.25 s$**

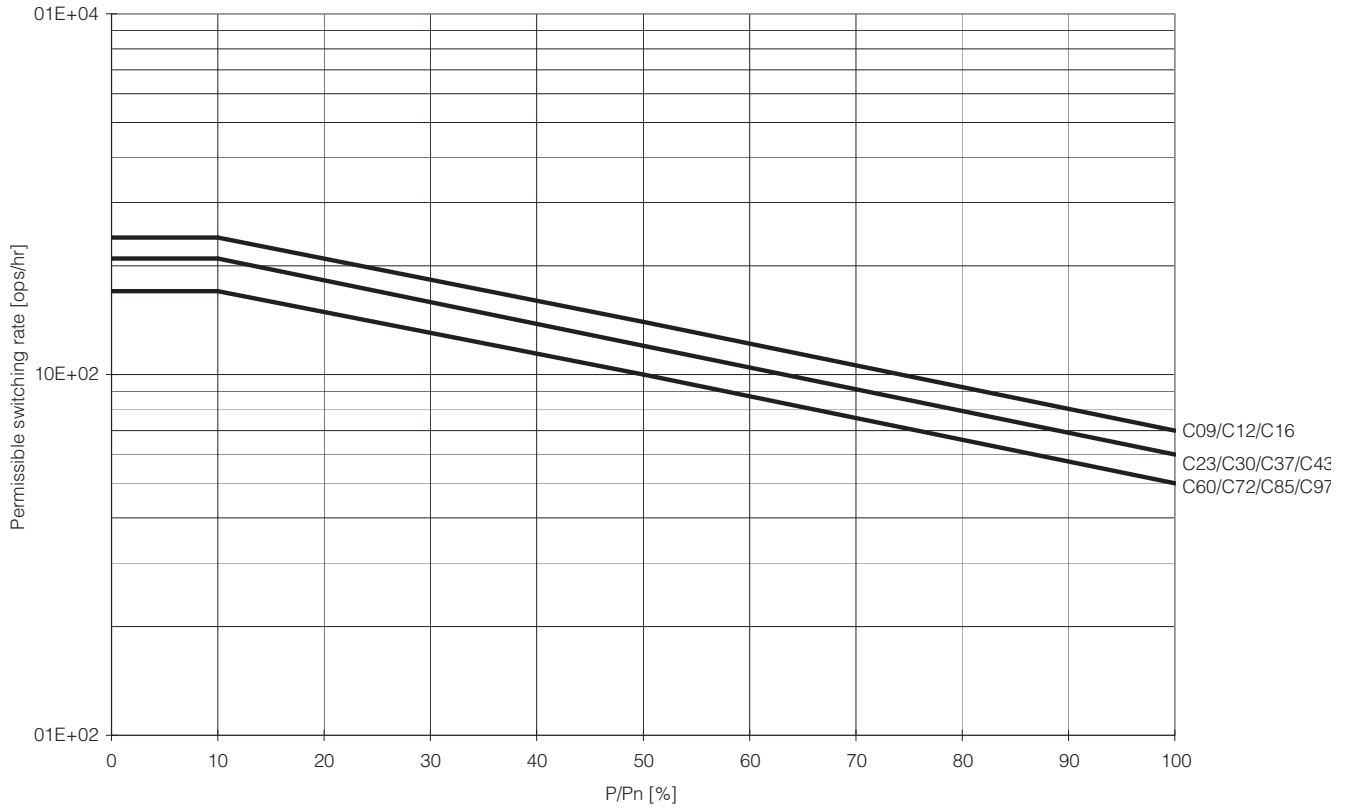
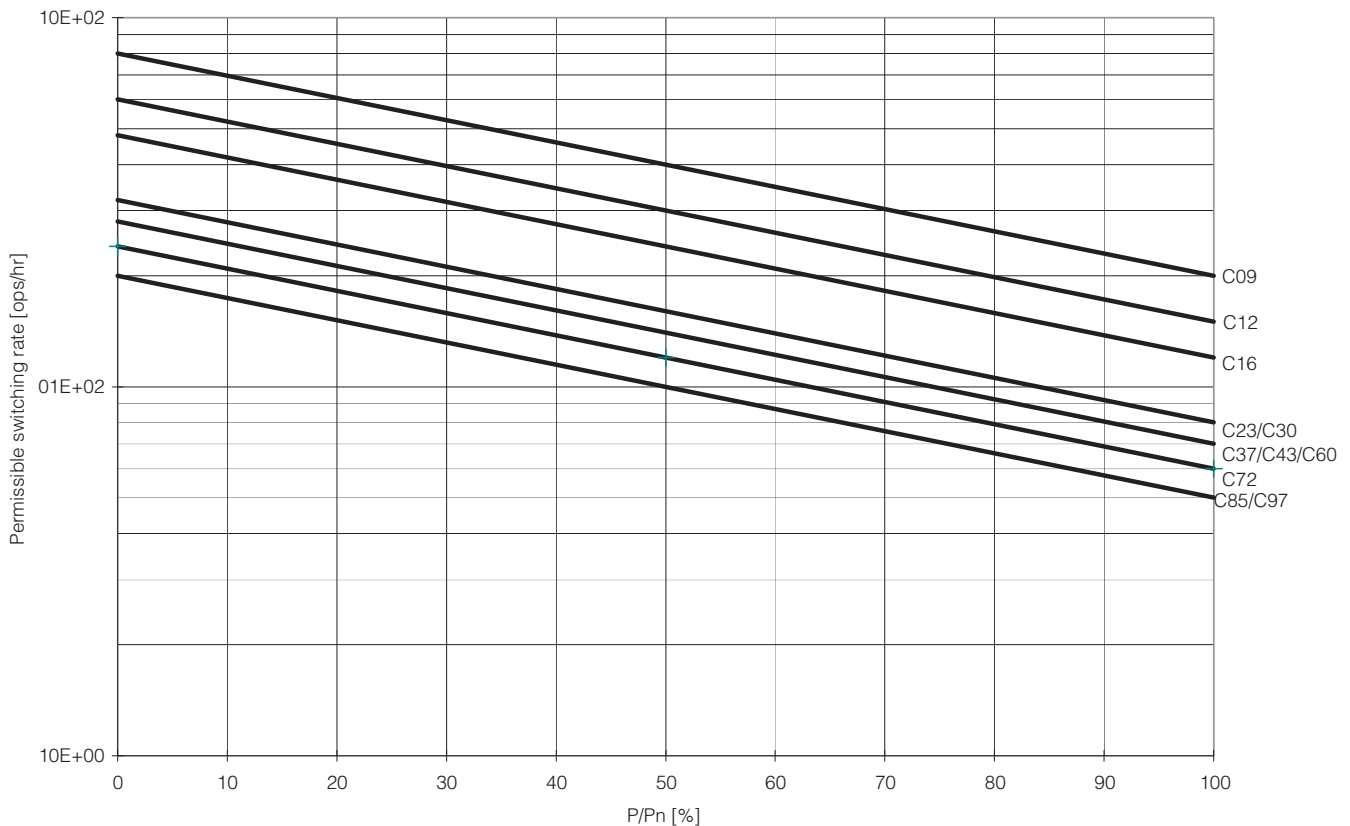

Figure 22 - AC-4, Inching of squirrel-cage motors; $U_e = 230...460V$, Starting time $t_A = 0.25 s$



Approximate Dimensions

Dimensions are shown in millimeters (inches). Dimensions are not intended for manufacturing purposes.

Figure 23 - Bulletin 100-C/100S-C Contactors and Accessories

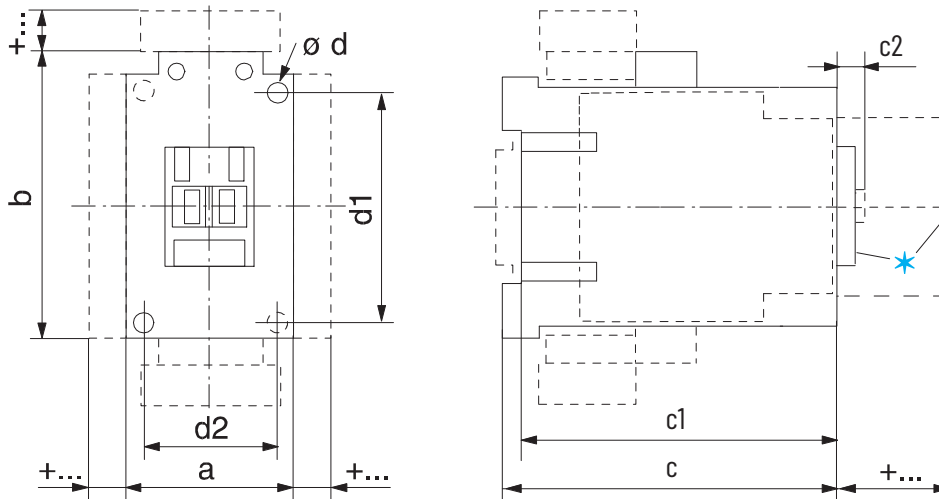

Figure 24 - Mounting Position – 100-C Contactors; 100S-C AC Contactors and DC Contactors with Electronic Coils

Figure 25 - Mounting Position – 100S-C DC Contactors with Conventional Coils

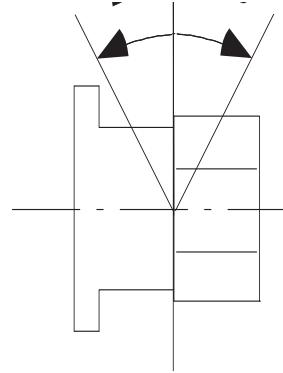
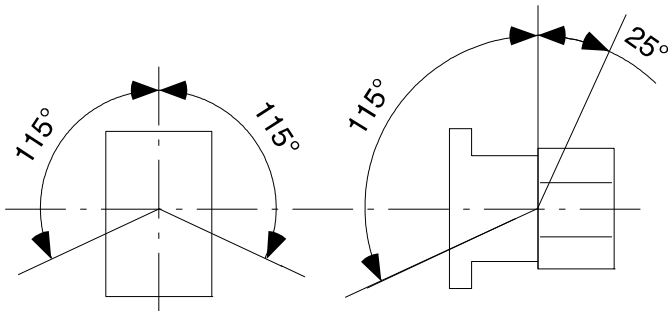

Table 24 - AC Contactors and DC Contactors with 12V or 24V Electronic Coils

Cat. No.	a	b	c	c1	c2	Ød	d1	d2
100-C09...100-C23	45 (1-25/32)	81 (3-3/16)	80.5 (3-11/64)	75.5 (2-31/32)	6 (15/64)	2 - 4.5 (2 - 3/16)	60 (2-23/64)	35 (1-3/8)
100-C30, 100-C37	45 (1-25/32)	81 (3-3/16)	97.5 (4)	92.5 (3-41/64)	6.5 (1/4)	2 - 4.5 (2 - 3/16)	60 (2-23/64)	35 (1-3/8)
100-C40	59 (2-21/64)	81 (3-3/16)	100.5 (3-61/64)	95.5 (3-49/64)	6.5 (1/4)	2 - 4.5 (2 - 3/16)	60 (2-23/64)	45 (1-25/32)
100-C43, 100-C55	54 (2-1/8)	81 (3-3/16)	100.5 (3-61/64)	95.5 (3-49/64)	6.5 (1/4)	2 - 4.5 (2 - 3/16)	60 (2-23/64)	45 (1-25/32)
100-C60...100-C97	72 (2-53/64)	122 (4-51/64)	117 (4-39/64)	111.5 (4-25/64)	8.5 (21/64)	4 - 5.4 (4 - 7/32)	100 (3-15/16)	55 (2-11/64)
100-C90	95 (3-47/64)	122 (4-51/64)	117 (4-39/64)	111.5 (4-25/64)	8.5 (21/64)	4 - 5.4 (4 - 7/32)	100 (3-15/16)	55 (2-11/64)
100S-C09...100S-C23	45 (1-25/32)	81 (3-3/16)	119.5 (4-3/4)	114.5 (4-43/64)	6 (15/64)	2 - 4.5 (2 - 3/16)	60 (2-23/64)	35 (1-3/8)
100S-C30, 100S-C37	45 (1-25/32)	81 (3-3/16)	136.5 (5-37/64)	131.6 (5-11/32)	6.5 (1/4)	2 - 4.5 (2 - 3/16)	60 (2-23/64)	35 (1-3/8)
100S-C43, 100S-C55	54 (2-1/8)	81 (3-3/16)	139.5 (5-11/16)	134.6 (5-29/64)	6.5 (1/4)	2 - 4.5 (2 - 3/16)	60 (2-23/64)	45 (1-25/32)
100S-C60...100S-C97	72 (2-53/64)	122 (4-51/64)	156 (6-11/32)	150.5 (6-1/8)	8.5 (21/64)	4 - 5.4 (4 - 7/32)	100 (3-15/16)	55 (2-11/64)

Table 25 - DC Contactors with Conventional Coils

Cat. No.	a	b	c	c1	c2	Ød	d1	d2
100-C60D...100-C97D	72 (2-53/64)	122 (4-51/64)	117 (4-39/64)	111.5 (4-25/64)	8.5 (21/64)	4 - 5.4 (4 - 7/32)	100 (3-15/16)	55 (2-11/64)
100-C90D	95 (3-47/64)	81 (3-3/16)	117 (4-39/64)	111.5 (4-25/64)	8.5 (21/64)	4 - 5.4 (4 - 7/32)	100 (3-15/16)	55 (2-11/64)
100S-C60D...100S-C97D	72 (2-53/64)	122 (4-51/64)	156 (6-11/32)	150.5 (6-1/8)	8.5 (21/64)	4 - 5.4 (4 - 7/32)	100 (3-15/16)	55 (2-11/64)

Table 26 - DC Contactors with 36...48V, 48...72V, 110...125V, or 200...250V DC Electronic Coils

Cat. No.	a	b	c	c1	c2	Ød	d1	d2
100-C09E...100-C23E	45 (1-25/32)	105 (4-1/8)	80.5 (3-11/64)	75.5 (2-31/32)	6 (15/64)	2 - 4.5 (2 -3/16)	60 (2-23/64)	35 (1-3/8)
100-C30E...100-C37E	45 (1-25/32)	105 (4-1/8)	97.5 (4)	92.5 (3-41/64)	6.5 (1/4)	2 - 4.5 (2 -3/16)	60 (2-23/64)	35 (1-3/8)
100-C40E	59 (2-21/64)	105 (4-1/8)	100.5 (3-61/64)	95.5 (3-49/64)	6.5 (1/4)	2 - 4.5 (2 -3/16)	60 (2-23/64)	45 (1-25/32)
100-C43E...100-C55E	54 (2-1/8)	105 (4-1/8)	100.5 (3-61/64)	95.5 (3-49/64)	6.5 (1/4)	2 - 4.5 (2 -3/16)	60 (2-23/64)	45 (1-25/32)
100S-C09E...100S-C23E	45 (1-25/32)	105 (4-1/8)	119.5 (4-3/4)	114.5 (4-43/64)	6 (15/64)	2 - 4.5 (2 -3/16)	60 (2-23/64)	35 (1-3/8)
100S-C30E...100S-C37E	45 (1-25/32)	105 (4-1/8)	136.5 (5-37/64)	131.6 (5-11/32)	6.5 (1/4)	2 - 4.5 (2 -3/16)	60 (2-23/64)	35 (1-3/8)
100S-C43E...100S-C55E	54 (2-1/8)	105 (4-1/8)	139.5 (5-11/16)	134.6 (5-29/64)	6.5 (1/4)	2 - 4.5 (2 -3/16)	60 (2-23/64)	45 (1-25/32)

Table 27 - 100-C/104-C Accessories

Contactors with		mm	(inches)
Auxiliary contact block for front mounting	2- or 4-pole	c/c1 + 39	(c/c1 + 1-37/64)
Auxiliary contact block for side mounting	1- or 2-pole	a + 9	(a + 23/64)
Pneumatic Timing Module		c/c1 + 58	(c/c1 + 2-23/64)
Electronic Timing Module	on coil terminal side	b + 24	(b + 15/16)
Mechanical Interlock	on side of contactor	a + 9	(a + 23/64)
Mechanical Latch		c/c1 + 63	(c/c1 + 2-31/64)
Interface Module	on coil terminal side	b + 9	(b + 23/64)
Surge Suppressor	on coil terminal side	b + 3	(b + 1/8)
Labeling with...	label sheet	+ 0	(+ 0)
	marking tag sheet with clear cover	+ 0	(+ 0)
	marking tag adapter for System Bul. 1492W	+ 5.5	(+ 7/32)
Terminal Lug Kit	100-C09...C23	b + 53	(b + 2-3/32)
	100-C30...C37	b + 44	(b + 1-47/64)
	100-C43...C55	b + 52	(b + 2-3/64)
	100-C60...C97	b + 99	(b + 3-7/8)
Paralleling Links	100-C09...C23	b + 78	(b + 3-1/16)
		c + 9/5	(c + 3/8)
	100-C30...C37	b + 85	(b + 3-11/32)
Auxiliary contact block for side mounting	1- or 2-pole	a + 9	(a + 23/64)
Electronic Timing Module	on coil terminal side	b + 24	(b + 15/16)
Mechanical Interlock	on side of contactor	a + 9	(a + 23/64)
Interface Module	on coil terminal side	b + 9	(b + 23/64)
Surge Suppressor	on coil terminal side	b + 3	(b + 1/8)
Labeling with	label sheet	+ 0	(+ 0)
	marking tag sheet with clear cover	+ 0	(+ 0)
	marking tag adapter for System Bul. 1492W	+ 5.5	(+ 7/32)

Product Selection—100-E/104-E Contactors

- 4...560 kW @ 400V
- 5...900 Hp @ 460V
- AC-1 ratings up to 2650 A
- Compact dimensions
- Electronic coils
 - AC/DC
 - Wide voltage range
 - Built-in surge suppression
 - Low power pick-up and hold-in
 - Optional PLC interface for 116...370 A contactors, standard on 400...2650 A contactors
- Direct-on-line or reversing
- 3 Main contacts
- Complete range of accessories
- Environmentally friendly



The Bulletin 100-E/104-E contactor family, along with a wide range of accessories, provides the most compact and flexible contactor system available.





3-Pole AC- and DC-operated Direct-on-line Contactors

Rated Operational Current I_e [A]		Ratings for switching AC motors - AC-2, AC-3											Auxiliary Contacts		Cat No.
60 °C	40 °C	kW (50 Hz)							Hp (60 Hz)						
AC-3 (400V)	AC-1 (690V)	220-240V	380-400V	415V	440V	500V	690V	1000V	200V	230V	460V	575V	N.O.	N.C.	
9	25	2.2	4	4	4	5.5	5.5	—	2	2	5	7.5	1	0	100-E09⊗10
													0	1	100-E09⊗01
12	28	3	5.5	5.5	5.5	7.5	7.5	—	3	3	7.5	10	1	0	100-E12⊗10
													0	1	100-E12⊗01
16	30	4	7.5	9	9	9	9	—	5	5	10	15	1	0	100-E16⊗10
													0	1	100-E16⊗01
26	45	6.5	11	11	15	15	15	—	7.5	7.5	15	20	0	0	100-E26⊗00
32	50	9	15	15	18.5	18.5	18.5	—	10	10	20	25	0	0	100-E30⊗00
38	50	11	18.5	18.5	22	22	22	—	10	10	25	30	0	0	100-E38⊗00
40	70	11	18.5	22	22	22	22	—	10	15	30	40	0	0	100-E40⊗00
52	100	15	22	30	30	30	30	—	15	20	40	50	0	0	100-E52⊗00
65	105	18.5	30	37	37	37	37	—	20	25	50	60	0	0	100-E65⊗00
80	125	22	37	45	45	45	45	35	25	30	60	75	0	0	100-E80⊗00
96	130	25	45	55	55	55	55	40	30	30	60	75	0	0	100-E96⊗00
116	160	37	55	55	75	75	63	55	30	40	75	100	1	1	100-E116⊗11 ⁽¹⁾
146	225	45	75	75	90	90	90	75	40	50	100	125	1	1	100-E146⊗11 ⁽¹⁾
190	275	55	90	90	110	110	132	110	50	60	125	150	1	1	100-E190⊗11
205	350	55	110	110	132	132	160	132	60	75	150	200	1	1	100-E205⊗11
265	400	75	132	132	160	160	200	160	75	100	200	250	1	1	100-E265⊗11
305	500	90	160	160	160	200	250	185	100	125	250	300	1	1	100-E305⊗11
370	600	110	200	200	200	250	315	200	125	150	300	350	1	1	100-E370⊗11
400	600	110	200	220	220	250	315	220	125	150	350	400	1	1	100-E400⊗11
460	700	132	250	250	250	315	355	280	150	200	400	500	1	1	100-E460⊗11
580	800	160	315	355	355	400	500	355	200	250	500	600	1	1	100-E580⊗11
750	1050	220	400	425	450	530	600	400	250	300	600	700	1	1	100-E750⊗11
860	1350	250	475	500	560	630	800	555	—	400	800	1000	1	1	100-E860⊗11
1060	1650	315	560	630	710	710	1000	600	—	450	900	1150	1	1	100-E1060⊗11
—	1260	—	—	—	—	—	—	—	—	—	—	—	1	1	100-E1260⊗11
—	2050	—	—	—	—	—	—	—	—	—	—	—	1	1	100-E2050⊗11
—	2650	—	—	—	—	—	—	—	—	—	—	—	1	1	100-E2650⊗11

(1) To order with built-in terminal lugs, add the letter "L" to the end of the catalog number (example: 100-E116⊗11L).



⊗ Coil voltage code and terminal position—see [page 60](#)

4-Pole AC- and DC-operated Direct-on-line Contactors

Rated Current at 40 °C [A]		Main Poles		Auxiliary Contacts		Cat No.
I_e	UL General Use (enclosed)					
AC-1 (690V)	600V	N.O.	N.C.	N.O.	N.C.	
25	25	4	0	0	0	100-E09⊗400
		2	2	0	0	100-E09⊗200
30	30	4	0	0	0	100-E16⊗400
		2	2	0	0	100-E16⊗200
45	45	4	0	0	0	100-E26⊗400
		2	2	0	0	100-E26⊗200
55	55	4	0	0	0	100-E38⊗400
		2	2	0	0	100-E38⊗200
70	60	4	0	0	0	100-E40⊗400
		2	2	0	0	100-E40⊗200
100	80	4	0	0	0	100-E52⊗400
125	105	4	0	0	0	100-E80⊗400
		2	2	0	0	100-E80⊗200

⊗ Coil voltage code and terminal position—see [page 60](#)

3-Pole AC- and DC-operated Reversing Contactors

Rated Operational Current I_e [A]		Ratings for switching AC motors - AC-2, AC-3											Auxiliary Contacts		Cat No.
60 °C	40 °C	kW (50 Hz)							Hp (60 Hz)						
AC-3 (400V)	AC-1 (690V)	220-240V	380-400V	415V	440V	500V	690V	1000V	200V	230V	460V	575V	N.O.	N.C.	
9	25	2.2	4	4	4	5.5	5.5	—	2	2	5	7.5	0	1	104-E09⊗02
													1	1 ⁽¹⁾	104-E09⊗22 ⁽²⁾
12	28	3	5.5	5.5	5.5	7.5	7.5	—	3	3	7.5	10	0	1	104-E12⊗02
													1	1 ⁽¹⁾	104-E12⊗22 ⁽²⁾
16	30	4	7.5	9	9	9	9	—	5	5	10	15	0	1	104-E16⊗02
													1	1 ⁽¹⁾	104-E16⊗22 ⁽²⁾
26	45	6.5	11	11	15	15	15	—	7.5	7.5	15	20	0	1 ⁽¹⁾	104-E26⊗02 ⁽²⁾
													1	1	104-E26⊗22
32	50	9	15	15	18.5	18.5	18.5	—	10	10	20	25	0	1 ⁽¹⁾	104-E30⊗02 ⁽²⁾
													1	1	104-E30⊗22
38	50	11	18.5	18.5	18.5	22	22	—	10	10	25	30	0	1 ⁽¹⁾	104-E38⊗02 ⁽²⁾
													1	1	104-E38⊗22
40	70	11	18.5	22	22	22	22	—	10	15	30	40	1	1	104-E40⊗22
52	100	15	22	30	30	30	30	—	15	20	40	50	1	1	104-E52⊗22
65	105	18.5	30	37	37	37	37	—	20	25	50	60	1	1	104-E65⊗22
80	125	22	37	45	45	45	45	35	25	30	60	75	1	1	104-E80⊗22
96	130	25	45	55	55	55	55	40	30	30	60	75	1	1	104-E96⊗22
116	160	55	55	55	75	75	63	55	30	40	75	100	1	1	104-E116⊗22 ⁽³⁾
146	225	75	75	75	90	90	90	75	40	50	100	125	1	1	104-E146⊗22 ⁽³⁾
190	275	90	90	90	110	110	132	110	50	60	125	150	1	1	104-E190⊗22
205	350	110	110	110	132	132	160	132	60	75	150	200	1	1	104-E205⊗22
265	400	132	132	132	160	160	200	160	75	100	200	250	1	1	104-E265⊗22
305	500	160	160	160	160	200	250	185	100	125	250	300	1	1	104-E305⊗22
370	600	200	200	200	200	250	315	200	125	150	300	350	1	1	104-E370⊗22
400	600	200	200	220	220	250	315	220	125	150	350	400	1	1	104-E400⊗22
460	700	250	250	250	250	315	355	280	150	200	400	500	1	1	104-E460⊗22
580	800	315	315	355	355	400	500	355	200	250	500	600	1	1	104-E580⊗22
750	1050	400	400	425	450	530	600	400	250	300	600	700	1	1	104-E750⊗22

(1) The N.C. auxiliary contact is supplied as part of the mechanical/electrical interlock.

(2) Not available with EQ or OJ coil codes.

(3) To order with built-in terminal lugs, add the letter "L" to the end of the catalog number (Example: 104-E116⊗22L).

⊗ Coil voltage code and terminal position—see [page 60](#)

Coil Voltage Codes

For 3-Pole Contactors

The Cat. No. as listed is incomplete. Select a coil voltage code from the table below to complete the Cat. No. Example: 100-E116KJ11

Electronic Coils	v ⁽¹⁾	12-20V DC	24V DC	24-60V AC, 20-60V DC	48-130V AC/DC	100-250V AC/DC	250-500V AC/DC
100-E09...100-E370	Standard AC/DC	—	—	KJ	KY	KD	KN
100-E09...100-E38	Low Consumption AC/DC	EQ	—	EJ	—	—	—
100-E09...100-E38	Low Consumption/ Faster Drop-out DC	—	QJ	—	—	—	—
100-E116...100-E370 ⁽²⁾	Standard AC/DC with PLC Input	—	—	—	—	ED	EN
100-E400...100-E750, 100-E1260		—	—	EJ ⁽³⁾	EY	ED	EN
100-E860...100-1060, 100-E2050...100-E2650		—	—	—	—	ED	—

- (1) AC voltages are at 50/60 Hz.
- (2) When ordering coil with PLC input, the PLC input must be used.
- (3) 24V...60V DC only.

For 3-Pole Reversing Contactors

The Cat. No. as listed is incomplete. Select a coil voltage code from the table below to complete the Cat. No. Example: 104-E116KJ11

Electronic Coils	v ⁽¹⁾	12-20V DC	24V DC	24-60V AC, 20-60V DC	48-130V AC/DC	100-250V AC/DC	250-500V AC/DC
104-E09...104-E370	Standard AC/DC	—	—	KJ	KY	KD	KN
104-E09...104-E38	Low Consumption AC/DC	EQ	—	EJ	—	—	—
104-E09...104-E38	Low Consumption/ Faster Drop-out DC	—	QJ	—	—	—	—
104-E116...104-E370 ⁽²⁾	Standard AC/DC with PLC Input	—	—	—	—	ED	EN
100-E400...104-E750, 104-E1260		—	—	EJ ⁽³⁾	EY	ED	EN
104-E860...104-1060, 104-E2050...104-E2650		—	—	—	—	ED	—

- (1) AC voltages are at 50/60 Hz.
- (2) When ordering coil with PLC input, the PLC input must be used.
- (3) 24V...60V DC only.

PLC Interface

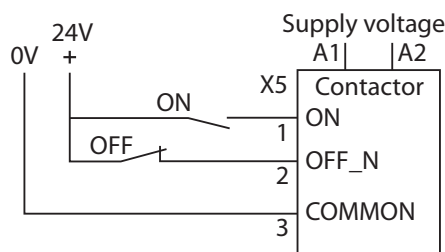

For 4-Pole Contactors

The Cat. No. as listed is incomplete. Select a coil voltage code from the table below to complete the Cat. No. Example: 100-E09KD400.

Electronic Coils	v ⁽¹⁾	12-20V DC	24V DC	24-60V AC, 20-60V DC	48-130V AC/DC	100-250V AC/DC	250-500V AC/DC
100-E09...100-E80	Standard AC/DC	—	—	KJ	KY	KD	KN
100-E09...100-E38	Low Consumption AC/DC	EQ	—	EJ	—	—	—
100-E09...100-E38	Low Consumption/ Faster Drop-out DC	—	QJ	—	—	—	—

- (1) AC voltages are at 50/60 Hz.

Product Selection—100S-E Safety Contactors

- Electronic Coils with built-in surge suppression
- 3 Main Contacts
- Direct-on-line
- Low-power auxiliary contacts for feedback circuit
- Mirror contact performance





100S-E09 Contactor





100S-E80 Contactor

3-Pole AC- and DC-operated Safety Contactors

Rated Operational Current I_e [A]		Ratings for switching AC motors - AC-2, AC-3											Auxiliary contacts per contactor			Direct-on-line Contactor
60 °C	40 °C	kW (50 Hz)							Hp (60 Hz)							
AC-3 (400V)	AC-1 (690V)	220-240V	380-400V	415V	440V	500V	690V	1000V	200V	230V	460V	575V	N.O.	N.C.	N.C. ⁽¹⁾	
9	25	2.2	4	4	4	5.5	5.5	—	2	2	5	7.5	2	0	3	100S-E09⊗23C
													1	0	4	100S-E09⊗14C
													3	0	2	100S-E09⊗32C
12	28	3	5.5	5.5	5.5	7.5	7.5	—	3	3	7.5	10	2	0	3	100S-E12⊗23C
													1	0	4	100S-E12⊗14C
													3	0	2	100S-E12⊗32C
16	30	4	7.5	9	9	9	9	—	5	5	10	15	2	0	3	100S-E16⊗23C
													1	0	4	100S-E16⊗14C
													3	0	2	100S-E16⊗32C
26	45	6.5	11	11	15	15	15	—	7.5	7.5	15	20	0	0	4	100S-E26⊗04C
													1	0	3	100S-E26⊗13C
													2	0	2	100S-E26⊗22C
													3	0	1	100S-E26⊗31C
32	50	9	15	15	18.5	18.5	18.5	—	10	10	20	25	0	0	4	100S-E30⊗04C
													1	0	3	100S-E30⊗13C
													2	0	2	100S-E30⊗22C
													3	0	1	100S-E30⊗31C
38	50	11	18.5	18.5	22	22	22	—	10	10	25	30	0	0	4	100S-E38⊗04C
													1	0	3	100S-E38⊗13C
													2	0	2	100S-E38⊗22C
													3	0	1	100S-E38⊗31C
40	70	11	18.5	22	22	22	22	—	10	15	30	40	0	0	4	100S-E40⊗04C
													1	0	3	100S-E40⊗13C
													2	0	2	100S-E40⊗22C
													3	0	1	100S-E40⊗31C
52	100	15	22	30	30	30	30	—	15	20	40	50	0	0	4	100S-E52⊗04C
													1	0	3	100S-E52⊗13C
													2	0	2	100S-E52⊗22C
													3	0	1	100S-E52⊗31C





(1) The N.C. contact meets IEC 60947-4-1 Annex F requirements for mirror contact performance.

3-Pole AC- and DC-operated Safety Contactors (Continued)

Rated Operational Current I_e [A]		Ratings for switching AC motors - AC-2, AC-3											Auxiliary contacts per contactor			Direct-on-line Contactor
60 °C	40 °C	kW (50 Hz)							Hp (60 Hz)							
AC-3 (400V)	AC-1 (690V)	220-240V	380-400V	415V	440V	500V	690V	1000V	200V	230V	460V	575V	N.O.	N.C.	N.C. ⁽¹⁾	Cat No.
65	105	18.5	30	37	37	37	37	—	20	25	50	60	0	0	4	100S-E65⊗04C
													1	0	3	100S-E65⊗13C
													2	0	2	100S-E65⊗22C
													3	0	1	100S-E65⊗31C
80	125	22	37	45	45	45	45	35	25	30	60	75	0	0	4	100S-E80⊗04C
													1	0	3	100S-E80⊗13C
													2	0	2	100S-E80⊗22C
													3	0	1	100S-E80⊗31C
96	130	25	45	55	55	55	55	40	30	30	60	75	0	0	4	100S-E96⊗04C
													1	0	3	100S-E96⊗13C
													2	0	2	100S-E96⊗22C
													3	0	1	100S-E96⊗31C
116	160	37	55	55	75	75	55	55	30	40	75	100	1	1	1	100S-E116⊗12C ⁽²⁾
146	225	45	75	75	90	90	90	75	40	50	100	125	1	1	1	100S-E146⊗12C ⁽²⁾
190	275	55	90	90	110	90	132	110	50	60	125	150	1	1	1	100S-E190⊗12C
205	350	55	110	110	132	110	160	132	60	75	150	200	1	1	1	100S-E205⊗12C
265	400	75	132	132	160	160	200	132	75	100	200	250	1	1	1	100S-E265⊗12C
305	500	90	160	160	160	200	250	132	100	125	250	300	1	1	1	100S-E305⊗12C
370	600	110	200	200	200	220	315	132	125	150	300	350	1	1	1	100S-E370⊗12C
400	600	110	200	220	220	250	315	220	125	150	350	400	1	1	1	100S-E400⊗12C
460	700	132	250	250	250	315	355	280	150	200	400	500	1	1	1	100S-E460⊗12C
580	800	160	315	355	355	400	500	355	200	250	500	600	1	1	1	100S-E580⊗12C
750	1050	220	400	425	450	530	600	400	250	300	600	700	1	1	1	100S-E750⊗12C



(1) The N.C. contact meets IEC 60947-4-1 Annex F requirements for mirror contact performance.
 (2) To order with built-in terminal lugs, add the letter "L" to the end of the catalog number (example: 100S-E116⊗12CL).

4-Pole AC- and DC-operated Safety Contactors

Rated Operational Current I_e [A]		Main Poles per contactor		Auxiliary contacts per contactor		Direct-on-line Contactor
40 °C						
AC-1	UL General Use (Enclosed)					
690V	600V	N.O.	N.C.	N.O.	N.C. ⁽¹⁾	Cat No.
25	25	4	0	0	4	100S-E09⊗404C
				1	3	100S-E09⊗413C
				2	2	100S-E09⊗422C
				3	1	100S-E09⊗431C
30	30	4	0	0	4	100S-E16⊗404C
				1	3	100S-E16⊗413C
				2	2	100S-E16⊗422C
				3	1	100S-E16⊗431C
45	45	4	0	0	4	100S-E26⊗404C
				1	3	100S-E26⊗413C
				2	2	100S-E26⊗422C
70	60	4	0	2	2	100S-E40⊗422C
100	80	4	0	2	2	100S-E52⊗422C
125	105	4	0	2	2	100S-E80⊗422C

(1) The N.C. contact meets IEC 60947-4-1 Annex F requirements for mirror contact performance.

3-Pole AC- and DC-operated Reversing Safety Contactors

Rated Operational Current I_e [A]		Ratings for switching AC motors - AC-2, AC-3											Auxiliary contacts per contactor		Direct-on-line Contactor
60 °C	40 °C	kW (50 Hz)							Hp (60 Hz)						
AC-3 (400V)	AC-1 (690V)	220-240V	380-400V	415V	440V	500V	690V	1000V	200V	230V	460V	575V	N.O.	N.C. ⁽¹⁾	Cat No.
9	25	2.2	4	4	4	5.5	5.5	—	2	2	5	7.5	1	4	104S-E09⊗28C
12	28	3	5.5	5.5	5.5	7.5	7.5	—	3	3	7.5	10	1	4	104S-E12⊗28C
16	30	4	7.5	9	9	9	9	—	5	5	10	15	1	4	104S-E16⊗28C
26	45	6.5	11	11	15	15	15	—	7.5	7.5	15	20	3	3	104S-E26⊗66C
32	50	9	15	15	18.5	18.5	18.5	—	10	10	20	25	3	3	104S-E30⊗66C
38	50	11	18.5	18.5	18.5	22	22	—	10	10	25	30	3	3	104S-E38⊗66C
40	70	11	18.5	22	22	22	22	—	10	15	30	40	3	3	104S-E40⊗66C
													1	5	104S-E40⊗210C
52	100	15	22	30	30	30	30	—	15	20	40	50	3	3	104S-E52⊗66C
													1	5	104S-E52⊗210C
65	105	18.5	30	37	37	37	37	—	20	25	50	60	3	3	104S-E65⊗66C
													1	5	104S-E65⊗210C
80	125	22	37	45	45	45	45	35	25	30	60	75	3	3	104S-E80⊗66C
													1	5	104S-E80⊗210C
96	130	25	45	55	55	55	55	40	30	30	60	75	3	3	104S-E96⊗66C
													1	5	104S-E96⊗210C

(1) The N.C. contact meets IEC 60947-4-1 Annex F requirements for mirror contact performance.

Coil Voltage Codes

For 3-Pole Safety Contactors

The Cat. No. as listed is incomplete. Select a coil voltage code from the table below to complete the Cat. No. Example: 100S-E09EJ14C

Electronic Coils	v ⁽¹⁾	12-20V DC	24V DC	24-60V AC, 20-60V DC	48-130V AC/DC	100-250V AC/DC	250-500V AC/DC
100S-E09...100S-E370	Standard AC/DC	—	—	KJ	KY	KD	KN
100S-E09...100S-E38	Low Consumption AC/DC	EQ	—	EJ	—	—	—
100S-E09...100S-E38	Low Consumption/ Faster Drop-out DC	—	QJ	—	—	—	—
100S-E116...100S-E370 ⁽²⁾	Standard AC/DC with 24V DC PLC Interface	—	—	—	—	ED	EN
100S-E400...100S-E750, 100S-E1260		—	—	EJ ⁽³⁾	EY	ED	EN
100S-E860...100S-E1060, 100S-E2050...100S-E2650		—	—	—	—	ED	—

PLC Interface

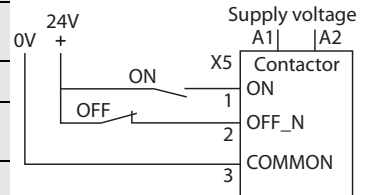

(1) AC voltages are at 50/60 Hz.

(2) When ordering coil with PLC input, the PLC input must be used.

(3) 24V...60V DC only.

For 3-Pole Reversing Safety Contactors

The Cat. No. as listed is incomplete. Select a coil voltage code from the table below to complete the Cat. No. Example: 104S-E09KD28C

Electronic Coils	v ⁽¹⁾	12-20V DC	24V DC	24-60V AC, 20-60V DC	48-130V AC/DC	100-250V AC/DC	250-500V AC/DC
104S-E09...104S-E96	Standard AC/DC	—	—	KJ	KY	KD	KN
104S-E09...104S-E38	Low Consumption AC/DC	EQ	—	EJ	—	—	—

(1) AC voltages are at 50/60 Hz.

For 4-Pole Safety Contactors

The Cat. No. as listed is incomplete. Select a coil voltage code from the table below to complete the Cat. No. Example: 100S-E09KD422C

Electronic Coils	v ⁽¹⁾	12-20V DC	24V DC	24-60V AC, 20-60V DC	48-130V AC/DC	100-250V AC/DC	250-500V AC/DC
100S-E09...100S-E96	Standard AC/DC	—	—	KJ	KY	KD	KN
100S-E09...100S-E38	Low Consumption AC/DC	EQ	—	EJ	—	—	—
100S-E09...100S-E38	Low Consumption/ Faster Drop-out DC	—	QJ	—	—	—	—

(1) AC voltages are at 50/60 Hz.

Assignment of Contacts

Table valid for: AC / DC = 0.85...1.1 x U_s, T_{amb} = -40 °C...+70 °C (-40 °F...158 °F), normal position (horizontal rail mounting)

Device Combinations in Accordance with IEC 60947-1 / -4-1

Auxiliary Contact Blocks		100-E Contactors (AC/DC Control)					
Circuit Diagram	Control				100-E26(1) 100-E30(1)	100-E09(1) 100-E16(1)	100-E09(2) 100-E16(2)
					100-E38(1)	100-E16(1)	100-E16(2)
		100-E09(1)	100-E09(2)	100-E40(3)	100-E26(2)	100-E26(2)	100-E26(2)
		100-E12(1)	100-E12(2)	100-E52(3)	100-E38(2)	100-E38(2)	100-E38(2)
		100-E16(1)	100-E16(2)	100-E65(3)	100-E40(3)	100-E40(4)	100-E40(4)
				100-E80(3)	100-E52(3)	100-E80(4)	100-E80(4)
				100-E96(3)	100-E80(3)		

Side Mounting

100-ESB11		AC/DC	10 + 11 = 21 ⁽⁵⁾	01 + 11 = 12 ⁽⁵⁾	00 + 11 = 11	00 + 11 = 11	00 + 11 = 11
-----------	--	-------	-----------------------------	-----------------------------	--------------	--------------	--------------

Front Mounting

100-EFA01		AC/DC	10 + 01 = 11	01 + 01 = 02	00 + 01 = 01	00 + 01 = 01	00 + 01 = 01
100-EFA10		AC/DC	10 + 10 = 20	01 + 10 = 11	00 + 10 = 10	00 + 10 = 10	00 + 10 = 10
100-EFAL01		AC/DC	10 + L01 = L11	01 + L01 = L02	00 + L01 = L01	00 + L01 = L01	00 + L01 = L01
100-EFAL10		AC/DC	10 + L10 = L20	01 + L10 = L11	00 + L10 = L10	00 + L10 = L10	00 + L10 = L10
100-EFA04		AC/DC	10 + 04 = 14	---	00 + 04 = 04	00 + 04 = 04	---
100-EFA13		AC/DC	10 + 13 = 23	01 + 13 = 14	00 + 13 = 13	00 + 13 = 13	00 + 13 = 13
100-EFA22		AC/DC	10 + 22 = 32	01 + 22 = 23	00 + 22 = 22	00 + 22 = 22	00 + 22 = 22

Device Combinations in Accordance with IEC 60947-1 / -4-1

Auxiliary Contact Blocks		100-E Contactors (AC/DC Control)					
100-EFA31		AC/DC	10 + 31 = 41	01 + 31 = 32	00 + 31 = 31	00 + 31 = 31	00 + 31 = 31
100-EFA40		AC/DC	10 + 40 = 50	01 + 40 = 14	00 + 40 = 40	00 + 40 = 40	00 + 40 = 40
100-EFB04		AC/DC	---	---	00 + 04 = 04	00 + 04 = 04	---
100-EFB22		AC/DC	---	---	00 + 22 = 22	00 + 22 = 22	00 + 22 = 22
100-EFB31		AC/DC	---	---	00 + 31 = 31	00 + 31 = 31	00 + 31 = 31
100-EFB40		AC/DC	---	---	00 + 40 = 40	00 + 40 = 40	00 + 40 = 40
100-EFC04		AC/DC	10 + 04 = 14	---	---	---	---
100-EFC13		AC/DC	10 + 13 = 23	---	---	---	---
100-EFC22		AC/DC	10 + 22 = 32	---	---	---	---
100-EFC31		AC/DC	10 + 31 = 41	---	---	---	---
100-EFB11T		AC/DC	---	---	00 + 11 = 11 ⁽⁶⁾	00 + 11 = 11 ⁽⁶⁾	00 + 11 = 11 ⁽⁶⁾
100-EFC11T		AC/DC	10 + 11 = 32	---	---	---	---

- (1) Maximum 6 auxiliary contacts possible with up to 4 N.C., front or side mounted
- (2) Maximum 6 auxiliary contacts possible with up to 3 N.C., front or side mounted
- (3) Maximum 8 auxiliary contacts possible with up to 6 N.C., front or side mounted
- (4) Maximum 8 auxiliary contacts possible with up to 2 N.C., front or side mounted
- (5) Double numbering: because of double numbering, only left-side mounting is recommended
- (6) Not for use on 100-E80...E96 contactors

Device Combinations in Accordance with IEC 60947-1 / -4-1

Auxiliary Contact Blocks		100-E Contactors (AC/DC Control)															
Circuit Diagram	Control	100-E116	100-E146	100-E190	100-E205	100-E265	100-E305	100-E370	100-E400	100-E460	100-E580	100-E750	100-E1260	100-E860	100-E1060	100-E2050	100-E2650

Side Mounting⁽¹⁾

100-ES1-11		AC/DC	11 + 11 = 22	---	---
100-ES2-11		AC/DC	11 + 11 = 22	---	---
100-ES3-11		AC/DC	---	11 + 11 = 22	11 + 11 = 22
100-ES4-11		AC/DC	---	11 + 11 = 22	11 + 11 = 22
100-ES1-B01 ⁽²⁾		AC/DC	11 + 01 = 12	---	---
100-ES1-B10 ⁽²⁾		AC/DC	11 + 10 = 21	---	---
100-ES3-B01 ⁽²⁾		AC/DC	---	11 + 01 = 12	11 + 01 = 12
100-ES3-B10 ⁽²⁾		AC/DC	---	11 + 10 = 21	11 + 10 = 21

(1) Maximum 8 auxiliary contacts possible with up to 4 N.C.
 (2) Maximum 6 auxiliary contacts possible when using the 100-ES*-B01 or 100-ES*-B10.

Safety Contactors with three main contacts front-mount auxiliary contacts

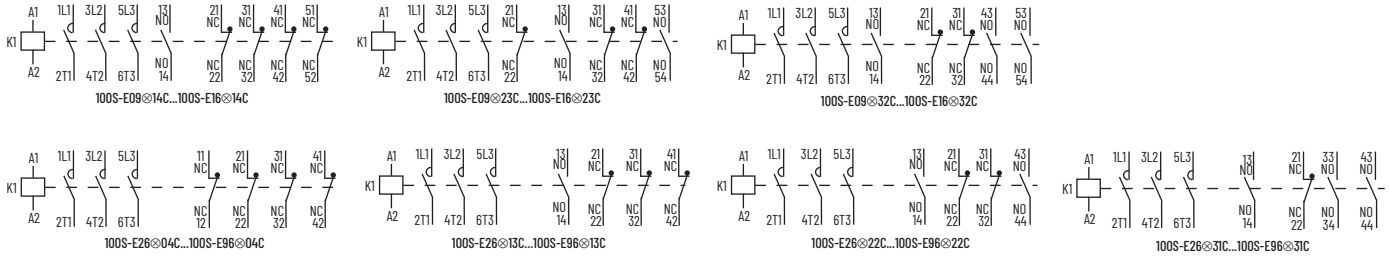

Safety Contactors with four main contacts front-mount auxiliary contacts

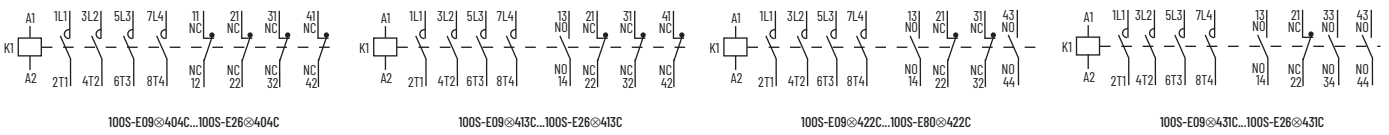

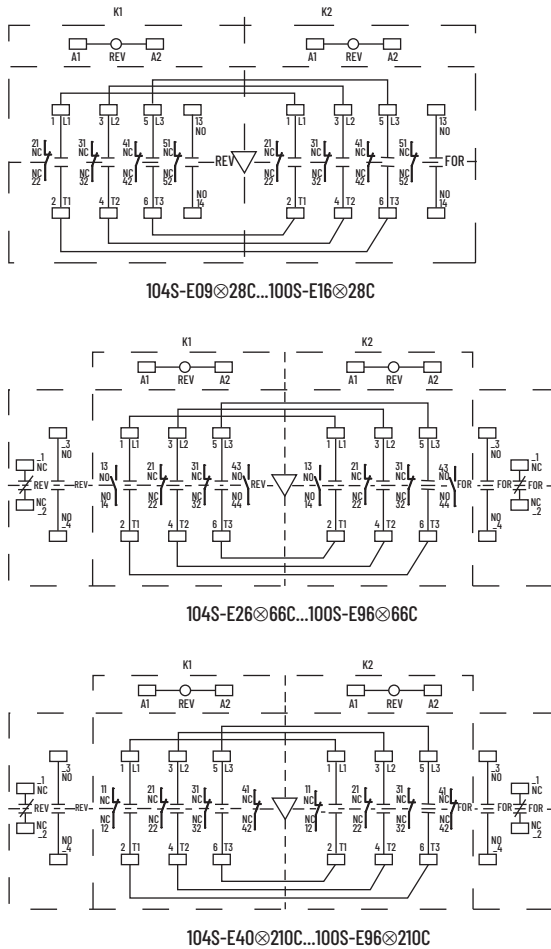

Safety Reversing Contactors with three main contacts front-mount auxiliary contacts











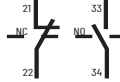
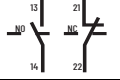

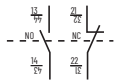
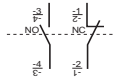
Accessories

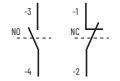
Auxiliary Contact Blocks with Standard Auxiliary Contacts

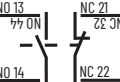
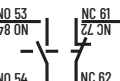

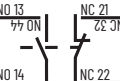
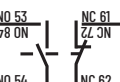

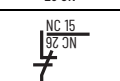
	Description	Connection Diagrams		For Use With	Cat. No.	
		N.O.	N.C.			
 <p>Auxiliary Contact Blocks for Front Mounting</p> <ul style="list-style-type: none"> • 1-pole • Quick and easy mounting without tools • Screw connection terminals • Switching down to 12V, 3mA • Mirror contact performance to the main contactor poles • L= Late break N.C./early make N.O. 		1	0	100-E09...100-E96	100-EFA10	
		0	1		100-EFA01	
		1L	0	100-E09...100-E96	100-EFAL10	
		0	1L		100-EFAL01	
 <p>Auxiliary Contact Blocks for Front Mounting</p> <ul style="list-style-type: none"> • 4-pole • Quick and easy mounting without tools • Screw connection terminals • Switching down to 12V 3mA • Mirror contact performance to the main contactor poles 		2	2	100-E09⊗10...100-E16⊗10	100-EFC22	
		3	1		100-EFC31	
		1	3		100-EFC13	
		0	4		100-EFC04	
		2	2	100-E26⊗00...100-E96⊗00 100-E09⊗400...100-E80⊗400 100-E09⊗200...100-E80⊗200	100-EFB22	
		3	1		100-EFB31	
		4	0		100-EFB40	
		0	4		100-EFB04	
	 <p>Auxiliary Contact Blocks for Front Mounting</p> <ul style="list-style-type: none"> • 4-pole • Quick and easy mounting without tools • Screw connection terminals • Switching down to 12V 3mA • Mirror contact performance to the main contactor poles 		2	2	100-E09...100-E96	100-EFA22
			3	1		100-EFA31
			4	0		100-EFA40
			1	3		100-EFA13
		0	4	100-EFA04		

Auxiliary Contact Blocks with Standard Auxiliary Contacts (Continued)

	Description	Connection Diagrams		For Use With	Cat. No.	
		N.O.	N.C.			
	Auxiliary Contact Blocks for Front Mounting with A1/A2 Coil Terminal Blocks <ul style="list-style-type: none"> • 2-pole • Quick and easy mounting without tools • Screw connection terminals • Switching down to 12V, 3mA • Mirror contact performance to the main contactor poles 	1	1		100-E09⊗10...100-E16⊗10	100-EFC11T
		1	1		100-E26⊗00...100-E65⊗00 100-E09⊗400...100-E52⊗400 100-E09⊗200...100-E40⊗200	100-EFB11T
	Auxiliary Contact Blocks for Side Mounting <ul style="list-style-type: none"> • 2-pole • Two-way numbering for right or left mounting on the contactor • With or without sequence terminal designations • Quick and easy mounting without tools • Screw connecting terminals • Switching down to 12V, 3mA • Mirror contact performance to the main contactor poles 	1	1		100-E26...100-E96	100-ESB11
		1	1		100-E09...100-E96	100-ESA11
	Auxiliary Contact Blocks for Front Mounting for Low-power Applications <ul style="list-style-type: none"> • 1-pole • Available in two IP degrees of ingress protection <ul style="list-style-type: none"> - B, B2 with built-in microswitch, IP40 degree of protection (IP20 terminals) - B3, B4 with built-in microswitch, IP67 degree of protection (IP20 terminals) • Available in two voltage and current ratings <ul style="list-style-type: none"> - B, B3: 125V, 0.1 A max., 3V, 1 mA min. - B2, B4: 250V, 2 A max., 17V, 1 mA min. 	1	0		100-E09...100-E96	100-ESA10B
		0	1			100-ESA01B
		1	0			100-ESA10B2
		0	1			100-ESA01B2
		1	0			100-ESA10B3
		0	1			100-ESA01B3
		1	0			100-ESA10B4
		0	1			100-ESA01B4
	Auxiliary Contact Blocks for Side Mounting with Sequence Terminal Designations <ul style="list-style-type: none"> • 2-pole • Two-way numbering for right or left mounting on the contactor • Quick and easy mounting without tools • Mirror contact performance to the main contactor poles • Low power switching down to 24V 50 mA 	1	1		100-E116...E370, left or right inside mounting	100-ES1-11
		1	1		100-E116...E370, left or right outside mounting	100-ES2-11
		1	0		100-E116...E370, left or right inside or outside mounting	100-ES1-B10
	Auxiliary Contact Blocks for Side Mounting with Sequence Terminal Designations <ul style="list-style-type: none"> • 2-pole • Two-way numbering for right or left side contactor mounting • Quick and easy mounting without tools • Mirror contact performance to the main contactor poles • Low power switching down to 24V 50 mA 	1	1		100-E400...E2650, left or right inside mounting	100-ES3-11
		1	1		100-E400...E2650, left or right outside mounting	100-ES4-11
		1	0		100-E400...E2650, left or right inside or outside mounting	100-ES3-B10
		0	1		100-E400...E2650, left or right inside or outside mounting	100-ES3-B01

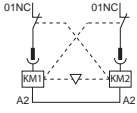

(1) No auxiliary contacts blocks can be mounted on the outside of the 100-ES1-B* or 100-ES3-B* devices.

Mechanical Interlocks

	Description		Connection Diagrams	For Use With	Cat. No.
	Mechanical Interlock • For interlocking of two contactors • Two fixing clips included	Mechanical only, without auxiliary contacts		100-E09...100-E38 (3 pole), 100-E09⊗400...100-E38⊗400	100-EMCA00A ⁽¹⁾
				100-E40...100-E96 (3 pole), 100-E40⊗400...100-E80⊗400	100-EMCA00B ⁽¹⁾
	Mechanical Interlock • For interlocking of two contactors. • Interlocking of different sizes possible	Mechanical only, without auxiliary contacts		100-E116...100-E146	100-EM1-00
				100-E190...100-E205	
				100-E265...100-E370	
				100-E116...100-E146 to 100-E190...100-E205	100-EM4-00
				100-E190...100-E205 to 100-E265...100-E370	100-EM5-00
				100-E400...100-E750, 100-E1260 ⁽²⁾	100-EM2-00
				100-E860...100-E1060, 100-E2050...100-E2650 ⁽³⁾	100-EM3-00
Rod for vertical mounting 100-E400...E750 reversing contactors	100-EVR750				
	Mechanical and Electrical Interlock • For interlocking of two contactors • Two fixing clips, a mechanical interlock and an electrical interlock block with A2-A2 connection included • Front-face connection of the electrical interlock block connects the 2 built-in N.C. interlocking contacts with the two coils • The electrical diagram is used with the A2-A2 connection	Mechanical/electrical interlock		100-E09...100-E38 (3 pole), 100-E09⊗400...100-E38⊗400	100-EMCA02 ⁽⁴⁾

- (1) Must be ordered in multiples of 10 pieces.
- (2) Mounting plate ordered separately.
- (3) Mounting plate included.
- (4) Not for use with contactors that have EQ or QJ coils.

Electronic Timers

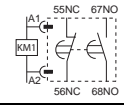
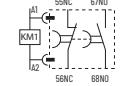
	Description		 		Connection Diagrams	For Use With	Cat. No.
			N.O.	N.C.			
	Electronic Timing Module—ON-Delay • Delay of the contactor coil • The contactor is energized at the end of the delay time	ON-Delay 0.1...1 s 1...10 s 10...100 s	1	1		100-E09...100-E96, 24...240V AC/DC	100-ETA
	Electronic Timing Module—OFF-Delay • Delay of the contactor coil • After interruption of the control signal, the contactor is de-energized a the end of the delay time	OFF-Delay 0.1...1 s 1...10 s 10...100 s	1	1		100-E09...100-E96, 24...240V AC/DC	100-ETB

DC Interface Module

	Description	For Use With	Pkg. Qty.	Cat. No.
	DC Interface • Receives 24V DC signals from PLCs or other low output power sources and switches AC control power to operate the coils of the contactor • Coil voltage: 24...250V AC 50/60 Hz • Rated control circuit voltage U _c : 24VDC	100-E09...100-E96	1	100-EJE
			10	100-EJEM

Mechanical Latch

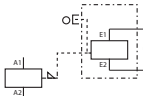
	Description	Rated Voltage [V]		Connection Diagram	For Use With	Cat. No.
		V AC, 50/60 Hz	V DC			
	Mechanical Latch <ul style="list-style-type: none"> Ensures contactor or contactor relay is switched on even if there is a voltage failure Opening controlled either electrically by AC or DC impulse or manually by button Front mounting 	24...60	24...60		100-E09...100-E65	100-EFL11KJ
		48...130	48...130			100-EFL11KY
		100...250	100...250			100-EFL11KD
		250...500	250...500			100-EFL11KN
		24...60	24...60		100-E80, 100-E96	100-EFL12KJ
		48...130	48...130			100-EFL12KY
		100...250	100...250			100-EFL12KD
		250...500	250...500			100-EFL12KN

Additional Coil Terminal Block

	Description	For Use With	Pkg. Qty.	Cat. No.
	Additional Coil Terminal Block <ul style="list-style-type: none"> Allows bottom access to the coil terminals in addition to top access 	100-E09...100-E96	10	100-ECT

Protective Covers

	Description	For Use With	Pkg. Qty.	Cat. No.
	Protective Cover <ul style="list-style-type: none"> Provides protection against unintended manual operation Sealable and Transparent 	100-E09...100-E96	10	100-ESCCA
		100-EF (4-pole only)	10	100-ESCFA

Functional Markers

	Description	For Use With	Pkg. Qty.	Cat. No.
	Functional Markers <ul style="list-style-type: none"> 256 markers (16 per card) printable on HTP500 thermal transfer printer and AMS 500 marking table 7 x 20 mm (0.276 x 0.787 in) 	100-E09...100-E96	16	100-EFMS

Terminal Block

	Description	For Use With	Pkg. Qty.	Cat. No.
	Additional Terminal Blocks <ul style="list-style-type: none"> Designed to increase wire size capacity of 3-pole contactors 3-pole terminal blocks with IP20 terminals 	100-E26...100-E38	2	100-ECT38



Terminal Shrouds

	Description	No. of Poles	For Use With	Cat. No.
	Terminal Shrouds <ul style="list-style-type: none"> IP20 terminal protection against accidental direct contact after wiring (EN 50274) 3-pole and 4-pole 	3-pole	100-E40...100-E65	100-ESC65
		3-pole	100-E80, 100-E96	100-ESC96
		4-pole	100-E40, 100-E52	100-ESC52
		4-pole	100-E80	100-ESC80

Paralleling Terminals

	Description	For Use With	Cat. No.
	Paralleling Terminals <ul style="list-style-type: none"> To connect poles in parallel and thus increase the AC-1 load passing through the flow path made up of the parallel-connected poles 	100-E09, 100-E12, 100-E16	100-ECP16
		100-E26, 100-E30, 100-E38	100-ECP38

Terminal Lugs





	Description	Wire Sizes	For Use With	Cat. No.
	Terminal Lug Kit <ul style="list-style-type: none"> Standard on 100-E116*L...100-E146*L contactors Set of two 	2 x 6 AWG...3/0 AWG	100-E116...100-E146	100-ECL146
	Terminal Lugs <ul style="list-style-type: none"> Set of three 10-32 threaded hole for customer-supplied control circuit tap screw 	6 AWG...300 MCM	100-E190...100-E205	100-ETL205
		4 AWG...400 MCM	100-E265...100-E370	100-ETL370
		(2x) 4 AWG...500 MCM	100-E265...100-E370	100-ETL370B
		(2x) 2/0 AWG...500 MCM	100-E400...100-E460	100-ETL580
		(3x) 2/0 AWG...500 MCM	100-E580...E750	100-ETL750
		(4x) 4/0 AWG...500 MCM	100-E860	100-ETL860
		(4x) 1/0 AWG...750 MCM	100-E1060	100-ETL1060
(6x) 1/0 AWG...750 MCM	100-E1060	100-ETL1060B		

Terminal Shrouds and Shields

	Description	Wires with Compression Lugs	Contactor with Terminal Lugs	For Use With	Cat. No.	
	Terminal Shrouds <ul style="list-style-type: none"> Not applicable when using 105-PW* or 170-PW* power wiring kits Pkg. Qty:2 	X	—	100-E116...100-E146	100-ETS146L	
		—	X	100-E190...100-E205	100-ETS205L	
		X	—	100-E190...100-E205	100-ETS205C	
		—	X	100-E265...100-E370	100-ETS370L ⁽¹⁾	
		X	—	100-E265...100-E370	100-ETS370C	
		—	X	100-E400...100-E460	100-ETS460L	
		X	—	100-E400...100-E460	100-ETS460C	
		—	X	100-E580...100-E750	100-ETS750L	
IP20 terminal shield between contactor and 193-E overload relay on an assembled direct-on-line starter		X	—	100-E580...100-E750, 100-E1260	100-ETS750C	
	IP20 terminal shield between contactor and 193-E overload relay on an assembled reversing starter				100-E116...100-E146	100-ETC146
					100-E190...100-E205	100-ETC205

(1) Not applicable when using the 100-ETL370B lug kit.

Power Wiring Kits

	Description	For Use With		Cat. No.
	Reversing Power Wiring Kits <ul style="list-style-type: none"> Used to connect the main poles of two 3-pole contactors mounted side by side 1 line-side paralleling and 1 load-side reversing connection Insulated, solid copper bars 	100-E09...100-E16		105-PW16
		100-E26...100-E38		105-PW38
		100-E40...100-E65		105-PW65
		100-E80, 100-E96		105-PW96
	Reversing Power Wiring Kits	100-E116...100-E146		105-PW146
		100-E190...100-E205		105-PW205 ⁽¹⁾
		100-E265...100-E370		105-PW370 ⁽¹⁾
		100-E400...100-E460		105-PW460 ⁽²⁾
		100-E580...100-E750		105-PW750 ⁽²⁾
	Wye-Delta Power Wiring Kits <ul style="list-style-type: none"> Used to connect the main poles of the Line, Delta and Star contactors of a star-delta starter. Connection sets are made up of: <ul style="list-style-type: none"> Line contactor / delta contactor, line-side phase-to-phase connection Delta contactor / star contactor, load-side connection in parallel Star contactor: star point line-side Insulated, solid copper bars 	Delta Contactor (1M/2M)	Wye Contactor (1S)	Cat. No.
		100-E09...100-E16	100-E09...100-E16	170-PW16
		100-E26...100-E38	100-E26...100-E38	170-PW38
		100-E40...100-E65	100-E40...100-E65	170-PW65
		100-E80, 100-E96	100-E40, 100-E65	170-PW96
	Wye-Delta Power Wiring Kits	Delta Contactor (1M/2M)	Wye Contactor (1S)	Cat. No.
		100-E116...100-E146	100-E116...100-E146	170-PW146
		100-E190...100-E205	100-E116...100-E146	170-PW190
		100-E190...100-E205	100-E190...100-E205	170-PW205
		100-E265...100-E370	100-E190...100-E205	170-PW265
		100-E265...100-E370	100-E265...100-E370	170-PW370
		100-E400...100-E460	100-E400...100-E460	170-PW460
		100-E580...100-E750	100-E400...100-E460	170-PW580
100-E580...100-E750	100-E580...100-E750	170-PW750		
	Shorting Bars	100-E116...100-E146		170-PWY146
		100-E190...100-E205		170-PWY205
		100-E265...100-E370		170-PWY370
		100-E400...100-E460		170-PWY460
		100-E580...100-E750		170-PWY750

(1) Kits includes one set of terminal extensions. If 100-ETL* terminal lugs are to be used on line and load side of reversing contactor, and second set of 100-ETX terminal extensions is required.
 (2) If 100-ETL* terminal lugs are to be used on line and load side of reversing contactor, two sets of 100-ETX terminal extensions are also required.



Mounting Plates

	Description	For Use With	Cat. No.
	For direct-on-line starters	100-E116...100-E146	100-EMS146
		100-E190...100-E205	100-EMS205
	For reversing contactors	100-E116...100-E146	100-EMR146
		100-E190...100-E205	100-EMR205
		100-E265...100-E370	100-EMR370
		100-E400...100-E460	100-EMR460
		100-E580...100-E750	100-EMR750
	For reversing starters	100-E116...100-E146	100-EMRS146
		100-E190...100-E205	100-EMRS205

Connectors

	Description	For Use With Circuit Breaker	For Use With Contactor	Cat. No.
 <p>For connection to 140G or 140MG</p> <ul style="list-style-type: none"> • Connection between contactors/starters and molded case circuit breakers. • These connection sets are solid copper bars. 		140G-H, 140MG-H	100-E116...100-E146	100-PCE1
		140G-I, 140MG-I	100-E116...100-E146	100-PCE2
		140G-J, 140MG-J	100-E116...100-E146	100-PCE3
		140G-J, 140MG-J	100-E190...100-E205	100-PCE4
		140G-K, 140MG-K	100-E265...100-E370	100-PCE5
		140G-M, 140MG-M	100-E400...100-E750	100-PCE6
		140G-K, 140MG-K	100-E400...100-E750	100-PCE7

Terminal Accessories

	Description	For Use With Contactor	Cat. No.
 <p>Terminal Enlargements</p> <ul style="list-style-type: none"> • Enlargement pieces designed to increase the width of the contactor terminal pads in order to allow larger connections to be mounted. 		100-E116...100-E146	100-ETE146
		100-E190...100-E205	100-ETE205
		100-E265...100-E370	100-ETE370
		100-E400...100-E460	100-ETE460
		100-E580...100-E750	100-ETE750
		100-E1260	100-ETE1260
 <p>Terminal Extensions</p> <ul style="list-style-type: none"> • Extension pieces designed to extend the main terminals of contactors for combined mounting of contactors and connection sets 		100-E116...100-E146	100-ETX146
		100-E190...100-E205	100-ETX205
		100-E265...100-E370	100-ETX370
		100-E400...100-E460	100-ETX460
		100-E580...100-E750	100-ETX750

Renewal Parts

Coil Modules

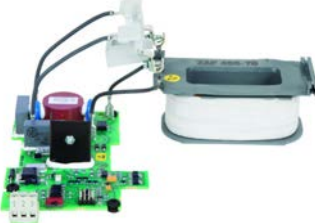
	Description	For Use With	Voltage	Cat. No.
	Coil Modules	100-E116	24...60V AC/DC	TG913
			48...130V AC/DC	TG914
			100...250V AC/DC	TG915
			250...500V AC/DC	TG916
			100...250V AC/DC w/ PLC Interface	TGE913
			250...500V AC/DC w/ PLC Interface	TGE914
		100-E146	24...60V AC/DC	TG901
			48...130V AC/DC	TG902
			100...250V AC/DC	TG903
			250...500V AC/DC	TG904
			100...250V AC/DC w/ PLC Interface	TGE903
			250...500V AC/DC w/ PLC Interface	TGE904
		100-E190, 100-E205	24...60V AC/DC	TG905
			48...130V AC/DC	TG906
			100...250V AC/DC	TG907
			250...500V AC/DC	TG908
		100-E190	100...250V AC/DC w/ PLC Interface	TGE915
			250...500V AC/DC w/ PLC Interface	TGE916
		100-E205	100...250V AC/DC w/ PLC Interface	TGE907
			250...500V AC/DC w/ PLC Interface	TGE908
		100-E265, 100-E305, 100-E370	24...60V AC/DC	TG909
			48...130V AC/DC	TG910
			100...250V AC/DC	TG911
			250...500V AC/DC	TG912
		100-E265	100...250V AC/DC w/ PLC Interface	TGE917
			250...500V AC/DC w/ PLC Interface	TGE918
		100-E305	100...250V AC/DC w/ PLC Interface	TGE919
			250...500V AC/DC w/ PLC Interface	TGE920
		100-E370	100...250V AC/DC w/ PLC Interface	TGE911
			250...500V AC/DC w/ PLC Interface	TGE912
		100-E400, 100-E460	24...60V DC w/ PLC Interface	THE901
			48...130V AC/DC w/ PLC Interface	THE902
100...250V AC/DC w/ PLC Interface	THE903			
250...500V AC/DC w/ PLC Interface	THE904			
100-E580, 100-E750, 100-E1260	24...60V DC w/ PLC Interface	TJE901		
	48...130V AC/DC w/ PLC Interface	TJE902		
	100...250V AC/DC w/ PLC Interface	TJE903		
	250...500V AC/DC w/ PLC Interface	TJE904		
100-E860, 100-E1060, 100-E2050	100...250V AC/DC w/ PLC Interface	TKE903 ⁽¹⁾		
		TKE904 ⁽²⁾		
100-E2650	100...250V AC/DC w/ PLC Interface	TLE903 ⁽¹⁾		
		TLE904 ⁽²⁾		

- (1) One set of two coils.
 (2) Printed circuit board.

Contact Kits

	Description	For Use With	Cat. No.
	Contact Kits	100-E116	100-EA116
		100-E146	100-EA146
		100-E190	100-EA190
		100-E205	100-EA205
		100-E2650	100-EA265
		100-E305	100-EA305
		100-E370	100-EA370
		100-E400	100-EA400
		100-E460	100-EA460
		100-E580	100-EA580
		100-E750	100-EA750
		100-E1260	100-EA1260
		100-E860	100-EA860
		100-E1060	100-EA1060
		100-E2050	100-EA2050
		100-E2650 ⁽¹⁾	100-EA2650
		Arc Chutes	100-E400, 100-E460
	100-E580, 100-E750, 100-E1260		100-EC750
	100-E860, 1060, 100-E2050		100-EC1060
	100-E2650		100-EC2650

(1) Movable contacts only.

Terminal and Mounting Hardware Kits

	Description	For Use With	Cat. No.
	Terminal and Mounting Hardware Kits	100-E116*L, 100-E146*L	100-EHS146 ⁽¹⁾
		100-E116, 100-E146	100-EHF146
		100-E190, 100-E205	100-EHF205
		100-E265, 100-E305, 100-E370	100-EHF370
		100-E400, 100-E460	100-EHF460
		100-E580, 100-E750, 100-E1260	100-EHF750
		100-E860, 100-E1060, 100-E2050	100-EHF2050
		100-E2650	100-EHF2650

(1) Mounting hardware only.

Specifications

Table 28 - General Specifications

			100-E, 100S-E, 104-E, 104S-E09...65	100-E, 100S-E, 104S-E80...96, 104-E80...2650
Rated Isolation Voltage U_i	IEC	[V]	690	1000
	UL, CSA	[V]	600	600
Rated Impulse Voltage Withstand U_{imp}		[kV]	6	8
Rated Voltage U_e	AC 50/60 Hz	[V]	115, 200, 230, 240, 400, 415, 460 500, 575, 690, 1000	
	DC	[V]	24, 48, 110, 220, 440	
Electromagnetic compatibility			IEC 60947-1 - Environment A and B ⁽¹⁾	
Insulation Class of the Coil			Class F per IEC 60947-4-1	
Rated coil frequency			AC 50/60 Hz, DC	
Ambient Temperature	Storage	[°C (°F)]	-60...+80 (-76...+176)	-40...+70 (-40...+158)
	Operation at rated voltage	[°C (°F)]	-40...+70 (-40...+158)	-40...+70 (-40...+158)
Max. Altitude of Installation Site		[m]	3000	
Climatic Withstand			Category B according to IEC 60947-1, Annex Q	
Resistance to Shock			IEC 60068-2-27	
Resistance to Vibration			IEC 60068-2-6	
Protection Class	Contactor main contacts		IP2X ⁽²⁾	IPO0 ⁽²⁾
	Contactor coil terminals		IP2X (in connected state)	
	Auxiliary contacts		IP2X (in connected state)	
Functional Safety Data (100S-E09...-E750): Usable for ISO 13849-1 and IEC 62061. Data is based on the B10 value given and: - Mission time/Proof test interval of 20 years. The B10 data for 100S-E116...100S-E750 is applicable for all coil codes, including the internal PLC Interface.	100S-E09...100S-E370		B10: 1.0E+06 operations at 50% max. AC-3 load; failure ratio: 75% failure to open, 25% failure to close	
	100S-E09...100S-E38		B10: 10.0E+06 operations, mechanical only; failure ratio: 50% failure to open, 50% failure to close	
	100S-E40...100S-E96		B10: 4.0E+06 operations, mechanical only; failure ratio: 50% failure to open, 50% failure to close	
	100S-E116...100S-E205		B10: 5.0E+06 operations, mechanical only; failure ratio: 50% failure to open, 50% failure to close	
	100S-E265...100S-E370		B10: 2.5E+06 operations, mechanical only; failure ratio: 50% failure to open, 50% failure to close	
	100S-E400...100S-E750		B10: 5.0E+05 operations at 50% max. AC-3 load; failure ratio: 75% failure to open, 25% failure to close	
	100S-E400...100S-E460		B10: 3.0E+06 operations, mechanical only; failure ratio: 50% failure to open, 50% failure to close	
	100S-E580...100S-E750		B10: 7.0E+05 operations, mechanical only; failure ratio: 50% failure to open, 50% failure to close	
	100S-E09...100S-E38 Electronic Components		Mean time to failure (MTTF): 233 years	
	100S-E40...100S-E96 Electronic Components		MTTF: 266 years	
100S-E116...100S-E750 PLC Interface		MTTF: 428 years		

(1) 100-E09...E38 only.

(2) 100-E40...E96 meet IP2X when used with 100-ESC... terminal shrouds.

Table 29 - Standards Compliance and Certifications

Standards Compliance	Certifications
• IEC/EN 60947-1, Low-voltage switchgear and controlgear	• cULus, File No. E41850 / E196120 (contactors, reversing contactors)
• IEC/EN 60947-4-1, Low-voltage switchgear and controlgear, Contactors and motor-starters	• UL
• IEC/EN 60947-5-1, Low-voltage switchgear and controlgear, Control circuit devices and switching elements	• CSA
• UL 60947-4-1, Industrial Control Equipment (USA)	• CCC
• CSA C22.2 No. 60947-4-1 Industrial Control Equipment (Canada).	• EAC
• Mechanically Linked Contacts: IEC 60947-5-1, Annex L (100/100S-E09...100/100S-E96 with all 100-E* front- and side-mounted N.C. auxiliary contacts)	• RCM
• Mirror Contacts: IEC 60947-4-1, Annex F (100/100S-E116...100/100S-E750 with all 100-ES* side-mounted N.C. auxiliary contacts)	• RINA
	• KC
	• CE
	• SUVA
	• SEMI-F47 (Conditions of use on request)

9...96 A Contactor Specifications

Table 30 - Main Circuits

100/104-E, 100S/104S-E			9	12	16	26	30	38	40	52	65	80	96
AC-1 Active Power Load (50/60Hz); Ambient temperature 40 °C (104 °F)													
Rated Operational Current, I_e	690V	[A]	25	28	30	45	50	50	70	100	105	125	130
	1000V	[A]	—	—	—	—	—	—	—	—	—	35	40
Rated Operational Power, P_e	230	[kW]	10	11	12	18	20	20	28	40	42	50	52
	240	[kW]	10	12	12	19	21	21	29	42	44	52	54
	400	[kW]	17	19	21	31	35	35	48	69	73	87	90
	415	[kW]	18	20	22	32	36	36	50	72	75	90	93
	500	[kW]	22	24	26	39	43	43	61	87	91	108	113
	690	[kW]	30	33	36	54	60	60	84	120	125	149	155
	1000	[kW]	—	—	—	—	—	—	—	—	—	61	69
Ambient temperature 60 °C (140 °F)													
Rated Operational Current, I_e	690V	[A]	25	28	30	40	42	42	60	80	90	100	105
	1000V	[A]	—	—	—	—	—	—	—	—	—	35	40
Rated Operational Power, P_e	230	[kW]	10	11	12	16	17	17	24	32	36	40	42
	240	[kW]	10	12	12	17	17	17	25	33	37	42	44
	400	[kW]	17	19	21	28	29	29	42	55	62	69	73
	415	[kW]	18	20	22	29	30	30	43	58	65	72	75
	500	[kW]	22	24	26	35	36	36	52	69	78	87	91
	690	[kW]	30	33	36	48	50	50	72	96	108	120	125
	1000	[kW]	—	—	—	—	—	—	—	—	—	61	69
Ambient temperature 70 °C (158 °F)													
Rated Operational Current, I_e	690V	[A]	22	24	26	32	37	37	50	70	80	85	90
	1000V	[A]	—	—	—	—	—	—	—	—	—	35	40
Rated Operational Power, P_e	230	[kW]	9	10	10	13	15	15	20	28	32	34	36
	240	[kW]	9	10	11	13	15	15	21	29	33	35	37
	400	[kW]	15	17	18	22	26	26	35	48	55	59	62
	415	[kW]	16	17	19	23	27	27	36	50	58	61	65
	500	[kW]	19	21	23	28	32	32	43	61	69	74	78
	690	[kW]	26	29	31	38	44	44	60	84	96	102	108
	1000	[kW]	—	—	—	—	—	—	—	—	—	61	69
With Conductor sizes	[mm ²]	4	6	6	10	10	10	25	35	35	50	50	

Table 31 - Main Circuits

100/104-E, 100S/104S-E		9	12	16	26	30	38	40	52	65	80	96	
Switching of 3-phase Motors; (50Hz) Ambient temperature 60 °C (140 °F) AC-2, AC-3													
Rated Operational Current, I_e	220-240V	[A]	9	12	18	26	33	40	40	53	65	80	96
	380-400V	[A]	9	12	18	26	32	38	40	53	65	80	96
	415V	[A]	9	12	18	26	32	38	40	53	65	80	96
	440V	[A]	9	12	18	26	32	38	40	53	65	80	96
	500V	[A]	9.5	12.5	15	23	28	33	40	45	55	65	80
	690V	[A]	7	9	10.5	17	21	24	25	35	39	49	57
	1000V	[A]	—	—	—	—	—	—	—	—	—	25	30
Rated Operational Power, P_e	220-240V	[kW]	2.2	3	4	6.5	9	11	11	15	18.5	22	25
	380-400V	[kW]	4.0	5.5	7.5	11	15	18.5	18.5	22	30	37	45
	415V	[kW]	4.0	5.5	9	11	15	18.5	22	30	37	45	55
	440V	[kW]	4.0	5.5	9	15	18.5	22.0	22	30	37	45	55
	500V	[kW]	5.5	7.5	9	15	18.5	22.0	22	30	37	45	55
	690V	[kW]	5.5	7.5	9	15	18.5	22.0	22	30	37	45	55
	1000V	[kW]	—	—	—	—	—	—	—	—	—	35	40
Load Carrying Capacity per UL/CSA													
General Purpose Current (enclosed)	600V	[A]	25	28	30	45	50	50	60	80	90	105	115
Rated Operational Current and Power (enclosed), 1-Phase	120V	[A]	13.8	16.0	20	24	24.0	24.0	34	34	56	80	80
	240V	[A]	10.0	12.0	17	17	28.0	28.0	40	50	68	68	88
	120V	[Hp]	0.75	1	1.5	2	2	2	3	3	5	7.5	7.5
	240V	[Hp]	1.5	2	3	3	5	5	7.5	10	15	15	20
Rated Operational Current and Power (enclosed), 3-Phase	200-208	[A]	7.8	11	17.5	25.3	32.2	32.2	32.2	48.3	62.1	78.2	92
	220-240	[A]	6.8	9.6	15.2	22.0	28	28	42	54	68	80	80
	440-480	[A]	7.6	11	14	21.0	27	34	40	52	65	77	77
	550-600	[A]	9	11	17	22.0	27	32	41	52	62	77	77
	200-208	[Hp]	2	3	5	7.5	10	10	10	15	20	25	30
	220-240	[Hp]	2	3	5	7.5	10	10	15	20	25	30	30
	440-480	[Hp]	5	7.5	10	15.0	20	25	30	40	50	60	60
	550-600	[Hp]	7.5	10	15	20.0	25	30	40	50	60	75	75
Rated Operational Current and Power (enclosed), with 3 poles in series	125V DC	[A]	9.5	13.2	17	25.0	25	25	40	58	76	76	110
	250V DC	[A]	8.5	8.5	12.2	12.2	20	29	38	55	72	89	106
	125V DC	[Hp]	1	1.5	2	3	3	3	5	7.5	10	10	15
	250V DC	[Hp]	2	3	3	5	7.5	7.5	10	15	20	25	30

Table 32 - Main Circuits

100/104-E, 100S/104S-E			9	12	16	26	30	38	40	52	65	80	96
Wye-Delta (60 Hz)													
Rated Operational Power, P _e	200V	[Hp]	3	5	7.5	10	15	15	15	25	30	40	50
	230V	[Hp]	3	5	7.5	10	15	15	25	30	40	50	50
	460V	[Hp]	7.5	10	15	25	30	40	50	60	75	100	100
	575V	[Hp]	10	15	25	30	40	50	60	75	100	125	125
Star-Delta Starting (50 Hz)													
Rated Operational Current, I _e	≥230V	[A]	9	12	18	26	33	40	40	53	65	80	96
	≥ 240V	[A]	9	12	18	26	32	38	40	53	65	80	96
	400V	[A]	9	12	18	26	32	38	40	53	65	80	96
	415V	[A]	9	12	18	26	32	38	40	53	65	80	96
	500V	[A]	9.5	12.5	15	23	28	33	40	45	55	65	80
	690V	[A]	7	9	10.5	17	21	24	25	35	39	49	57
	1000V	[A]	–	–	–	–	–	–	–	–	–	25	30
Rated Operational Power, P _e	230V	[kW]	4	5.5	7.5	11	15	18.5	18.5	22	30	37	45
	240V	[kW]	4	5.5	7.5	11	15	18.5	18.5	22	30	37	45
	400V	[kW]	7.5	7.5	15	22	30	30	37	45	55	75	90
	415V	[kW]	7.5	7.5	15	22	30	37	37	45	55	75	90
	500V	[kW]	7.5	11	15	22	30	37	45	45	55	75	90
	690V	[kW]	7.5	11	15	22	30	37	37	55	55	75	90
	1000V	[kW]	–	–	–	–	–	–	–	–	–	–	–

Table 33 - Main Circuits

100/104-E, 100S/104S-E			9	12	16	26	30	38	40	52	65	80	96
UL/CSA Elevator Duty													
Rated Operational Current and Power, 500,000 electrical operations, 1-Phase	115V AC	[A]	5.8	7.20	–	20	24	24	34	34	34	56	56
	230V AC	[A]	2.20	3.20	–	9.6	10	15.2	15.2	22	28	28	28
	115V AC	[Hp]	0.25	0.33	–	1.5	2	2	3	3	3	5	5
	230V AC	[Hp]	0.50	0.75	–	3	3	5	5	7.5	10	10	10
Rated Operational Current and Power, 500,000 electrical operations 3-Phase	200V AC	[A]	4.60	7.50	–	16.7	24.2	24.2	30.8	30.8	46.2	46.2	46.2
	230V AC	[A]	4.20	6.80	–	15.2	22	22	28	28	42	42	42
	460V AC	[A]	4.80	7.60	–	21.0	27	27	34	40	52	52	52
	575V AC	[A]	3.90	6.10	–	17	22	22	32	41	41	52	52
	200V AC	[Hp]	1	2	–	5	7.5	7.5	10	10	15	15	15
	230V AC	[Hp]	1	2	–	5	8	10	10	15	20	20	20
	460V AC	[Hp]	3	5	–	15	20	20	25	30	40	40	40
	575V AC	[Hp]	3	5	–	15	20	20	30	40	40	50	50
UL/CSA HVAC Applications Definite purpose rating (3-phase)													
FLA	600V	[A]	20	25	30	45	50	50	60	80	90	105	115
LRA	200-208V AC	[A]	120	150	180	270	300	300	360	480	540	630	690
	220-240V AC	[A]	120	150	180	270	300	300	360	480	540	630	690
	440-480V AC	[A]	120	150	180	270	300	300	360	480	540	630	690
	550-600V AC	[A]	80	100	120	180	200	200	240	320	360	420	460

Table 34 - Main Circuits

100/104-E, 100S/104S-E			9	12	16	26	30	38	40	52	65	80	96
Switching of Power Transformers, AC-6a (50 Hz)													
Inrush Current Rated transformer current = n													
n=30	230V	[A]	11.7	13.3	16.7	26.7	33.3	40.0	41.7	51.7	58.3	63.3	70.0
	240V	[A]	11.7	13.3	16.7	26.7	33.3	40.0	41.7	51.7	58.3	63.3	70.0
	400V	[A]	11.7	13.3	16.7	26.7	33.3	40.0	41.7	51.7	58.3	63.3	70.0
	415V	[A]	11.7	13.3	16.7	26.7	33.3	40.0	41.7	51.7	58.3	63.3	70.0
	500V	[A]	11.7	13.3	16.7	26.7	33.3	40.0	41.7	51.7	58.3	63.3	70.0
	690V	[A]	11.7	13.3	16.7	26.7	33.3	40.0	41.7	51.7	58.3	63.3	70.0
Apparent Power	230V	[kVA]	5	5	7	11	13	16	17	21	23	25	28
	240V	[kVA]	5	6	7	11	14	17	17	21	24	26	29
	400V	[kVA]	8	9	12	18	23	28	29	36	40	44	48
	415V	[kVA]	8	10	12	19	24	29	30	37	42	45	50
	500V	[kVA]	10	12	14	23	29	35	36	45	50	55	61
	690V	[kVA]	14	16	20	32	40	48	50	62	70	76	84
n=20	690V	[A]	17.5	20	25	40	50	60	62.5	77.5	87.5	95	105
n=15	690V	[A]	23.3	26.7	33.3	53.3	66.7	80.0	83.3	103	117	127	140
60 Hz Peak Inrush/peak rated transformer current													
n=30	600V	[A]	11.7	13.3	16.7	26.7	33.3	40.0	41.7	51.7	58.3	63.3	70.0
Apparent Power	200V	[kVA]	4	5	6	9	12	14	14	18	20	22	24
	208V	[kVA]	4	5	6	10	12	14	15	19	21	23	25
	240V	[kVA]	5	6	7	11	14	17	17	21	24	26	29
	480V	[kVA]	10	11	14	22	28	33	35	43	48	53	58
	600V	[kVA]	12	14	17	28	35	42	43	54	61	66	73
	n=20	600V	[A]	17.5	20.0	25.0	40.0	50.0	60.0	62.5	77.5	87.5	95.0
Apparent Power	200V	[kVA]	6	7	9	14	17	21	22	27	30	33	36
	208V	[kVA]	6	7	9	14	18	22	22	28	31	34	38
	240V	[kVA]	7	8	10	17	21	25	26	32	36	39	44
	480V	[kVA]	15	17	21	33	42	50	52	64	73	79	87
	600V	[kVA]	18	21	26	42	52	62	65	80	91	99	109
	n=15	600V	[A]	23.3	26.7	33.3	53.3	66.7	80.0	83.3	103	117	127
Apparent Power	200V	[kVA]	8	9	12	18	23	28	29	36	40	44	48
	208V	[kVA]	8	10	12	19	24	29	30	37	42	46	50
	240V	[kVA]	10	11	14	22	28	33	35	43	48	53	58
	480V	[kVA]	19	22	28	44	55	66	69	86	97	105	116
	600V	[kVA]	24	28	35	55	69	83	87	107	121	131	145
	Switching of Lighting Loads (UL/CSA)												
Tungsten lamps	1-phase per pole	347V [A]	20	25	30	45	50	50	65	80	90	105	115
	3-phase (break all lines)	600V [A]	20	25	30	45	50	50	65	80	90	105	115
Electrical discharge lamps (ballast)	1-phase per pole	347V [A]	20	25	30	45	50	50	65	80	90	105	115
	3-phase (break all lines)	600V [A]	20	25	30	45	50	50	65	80	90	105	115

Table 35 - Main Circuits

100/104-E, 100S/104S-E		9	12	16	26		30	38		40	52	65	80	96	
		3- or 4-Pole			3-Pole	4-Pole	3-Pole	3-Pole	4-Pole	3-Pole	3-Pole	3-Pole	3-Pole	3-Pole	
Switching of DC Loads—Non-inductive or slightly inductive loads or resistance furnaces DC-1 at 60 °C															
1 pole	≤ 72V	[A]	25	27	30	45	45	50	50	55	70	100	105	125	130
	110V	[A]	10	15	20	—	—	—	—	—	—	—	—	—	—
	220V	[A]	—	—	—	—	—	—	—	—	—	—	—	—	—
2 poles in series	≤ 72V	[A]	25	27	30	45	45	50	50	55	70	100	105	125	130
	110V	[A]	25	27	30	45	45	50	50	55	70	100	105	125	130
	220V	[A]	10	15	20	—	—	—	—	—	—	—	—	—	—
3 poles in series	≤ 72V	[A]	25	27	30	45	45	50	50	55	70	100	105	125	130
	110V	[A]	25	27	30	45	45	50	50	55	70	100	105	125	130
	220V	[A]	25	27	30	45	45	50	50	55	70	100	105	125	130
4 poles in series	≤ 72V	[A]	25	—	30	—	45	—	—	55	—	—	—	—	—
	110V	[A]	25	—	30	—	45	—	—	55	—	—	—	—	—
	220V	[A]	25	—	30	—	45	—	—	55	—	—	—	—	—
	440V	[A]	10	—	20	—	—	—	—	—	—	—	—	—	—
Shunt-wound Motors—Starting, reverse current breaking, reversing, stepping: DC-3 at 60 °C															
1 pole	≤ 72V	[A]	25	27	30	45	—	50	50	—	70	100	105	125	130
	110V	[A]	6	7	8	—	—	—	—	—	—	—	—	—	—
	220V	[A]	—	—	—	—	—	—	—	—	—	—	—	—	—
2 poles in series	≤ 72V	[A]	25	27	30	45	—	50	50	—	70	100	105	125	130
	110V	[A]	25	27	30	45	—	50	50	—	70	100	105	125	130
	220V	[A]	6	7	8	—	—	—	—	—	—	—	—	—	—
3 poles in series	≤ 72V	[A]	25	27	30	45	—	50	50	—	70	100	105	125	130
	110V	[A]	25	27	30	45	—	50	50	—	70	100	105	125	130
	220V	[A]	25	27	30	45	—	50	50	—	70	100	105	125	130
4 poles in series	≤ 72V	[A]	25	—	30	—	—	—	—	—	—	—	—	—	—
	110V	[A]	25	—	30	—	—	—	—	—	—	—	—	—	—
	220V	[A]	25	—	30	—	—	—	—	—	—	—	—	—	—
	440V	[A]	6	—	8	—	—	—	—	—	—	—	—	—	—
Series-wound Motors—Starting, reverse current breaking, reversing, stepping: DC-5 at 60 °C															
1 pole	≤ 72V	[A]	9	12	16	20	—	25	25	—	70	100	105	125	130
	110V	[A]	4	4	4	—	—	—	—	—	—	—	—	—	—
	220V	[A]	—	—	—	—	—	—	—	—	—	—	—	—	—
2 poles in series	≤ 72V	[A]	25	27	30	45	—	50	50	—	70	100	105	125	130
	110V	[A]	10	15	20	45	—	50	50	—	70	100	105	125	130
	220V	[A]	4	4	4	—	—	—	—	—	—	—	—	—	—
3 poles in series	≤ 72V	[A]	25	27	30	45	—	50	50	—	70	100	105	125	130
	110V	[A]	25	27	30	45	—	50	50	—	70	100	105	125	130
	220V	[A]	9	12	16	20	—	25	25	—	70	100	105	125	130
4 poles in series	≤ 72V	[A]	25	—	30	—	—	—	—	—	—	—	—	—	—
	110V	[A]	25	—	30	—	—	—	—	—	—	—	—	—	—
	220V	[A]	10	—	20	—	—	—	—	—	—	—	—	—	—
	440V	[A]	4	—	4	—	—	—	—	—	—	—	—	—	—
Short Time Withstand I_{CW} 40 °C (104 °F)															
3- and 4-Pole	1 s	[A]	300	300	300	700	700	700	700	700	1000	1000	1000	1200	1200
	10 s	[A]	150	150	150	350	350	350	350	350	600	600	600	780	780
	30 s	[A]	80	80	80	225	225	225	225	225	350	350	350	450	450
	1 min	[A]	60	60	60	150	150	150	150	150	250	250	250	300	300
	15 min	[A]	35	35	35	50	50	50	50	50	110	110	110	140	140

Table 36 - Main Circuits

100/104-E, 100S/104S-E		9	12	16	26	30	38	40	52	65	80	96	
		3-Pole			3-Pole	3-Pole	3-Pole	3-Pole	3-Pole	3-Pole	3-Pole	3-Pole	
Resistance and Power Dissipation													
Main current circuit resistance		[mΩ]	1.23	1.39	1.08	0.89	0.88	0.9	0.63	0.61	0.64	0.47	0.49
Power dissipation per pole at I_e AC-1, 400V		[W]	0.8	1	1.2	1.8	2.4	2.4	3	6.3	7	7.6	8.2
Power dissipation per pole at I_e AC-3, 400V		[W]	0.1	0.2	0.35	0.6	0.9	1.3	1	1.7	2.7	3	4.5
Total Power dissipation at: I_e AC-3, 400V; AC/DC control (120-250V)		[W]	2.3	2.6	3.1	3.8	4.7	5.9	5	7.1	10.1	11	15.5
Maximum Switching Frequency	AC-1	ops/hr	600 cycles/h										
	AC-3	ops/hr	1200 cycles/h										
	AC-2, AC-4	ops/hr	300 cycles/h				150 cycles/h						
Lifespan, mechanical		[Million ops.]	10	10	10	10	10	10	4	4	4	4	4
Weight													
AC/DC Coil Codes	KJ, KY	[kg (lbs.)]	0.27 (0.59)	0.27 (0.59)	0.27 (0.59)	0.31 (0.68)	0.31 (0.68)	0.31 (0.68)	0.97 (2.13)	0.97 (2.13)	0.97 (2.13)	1.22 (2.68)	1.22 (2.68)
	KD	[kg (lbs.)]	0.27 (0.59)	0.27 (0.59)	0.27 (0.59)	0.31 (0.68)	0.31 (0.68)	0.31 (0.68)	0.95 (2.09)	0.95 (2.09)	0.95 (2.09)	1.17 (2.57)	1.17 (2.57)
	KN	[kg (lbs.)]	0.31 (0.68)	0.31 (0.68)	0.31 (0.68)	0.35 (0.77)	0.35 (0.77)	0.35 (0.77)	0.95 (2.09)	0.95 (2.09)	0.95 (2.09)	1.17 (2.57)	1.17 (2.57)
DC Coil Codes	E0, EJ	[kg (lbs.)]	0.31 (0.68)	0.31 (0.68)	0.31 (0.68)	0.35 (0.77)	0.35 (0.77)	0.35 (0.77)	—	—	—	—	—
	0J	[kg (lbs.)]	0.43 (0.95)	0.43 (0.95)	0.43 (0.95)	0.48 (1.06)	0.48 (1.06)	0.48 (1.06)	—	—	—	—	—

Table 37 - Short-circuit Current Ratings

100/104-E, 100S/104S-E		9	12	16	26	30	38	40	52	65	80	96
Short Circuit Coordination (Max. Fuse or Circuit Breaker Rating) Per IEC 60947-4-1												
DIN FUSES- gG	Type "2" (400V)	[A]	100 kA Available Fault Current									
			32	32	35	62	80	80	100	125	125	160
MCCB (140G-H)	Type "2" (690V)	[A]	60 kA Available Fault Current									
			6	10	16	32	32	40	40	63	80	80
MCCB (140G-H)	Type "2" (400V)	[A]	70 kA Available Fault Current									
							15	20	50	80	80	80
Short Circuit Current Rating (Max. Fuse or Circuit Breaker Rating) Per UL 60947 and CSA 22.2 No. 14 (contactor and fuses or circuit breaker only)												
UL Class RK5 Fuses	Type 1 Combination (600V)	[A]	5 kA Available Fault Current									
			30	30	60	60	100	100	150	150	—	—
UL Class RK5 Fuses	Type 1 Combination (600V)	[A]	10 kA Available Fault Current									
			—	—	—	—	—	—	—	—	150	200
UL Class J and CSA HRCI-J Fuses	Type 1 Combination (600V)	[A]	100 kA Available Fault Current									
			30	30	60	60	100	100	150	150	150	200

Table 37 - Short-circuit Current Ratings (Continued)

100/104-E, 100S/104S-E			9	12	16	26	30	38	40	52	65	80	96
UL Inverse-Time Circuit Breaker	Type 1 Combination (480V)	[A]	5 kA Available Fault Current										
			60	60	60	100	125	125	250	250	—	—	—
	Type 1 Combination (480V)	[A]	10 kA Available Fault Current										
			60	60	60	—	—	—	—	—	250	250	250
	Type 1 Combination (480V)	[A]	65 kA Available Fault Current										
			—	—	—	100	—	—	250	250	250	250	250
	Type 1 Combination (480V)	[A]	100 kA Available Fault Current										
			—	—	—	—	125	125	—	—	—	100	100
	Type 1 Combination (600V)	[A]	5 kA Available Fault Current										
			60	60	—	—	125	125	250	250	—	—	—
Type 1 Combination (600V)	[A]	10 kA Available Fault Current											
		—	—	60	—	—	—	250	250	250	250	250	
Type 1 Combination (600V)	[A]	25 kA Available Fault Current											
		—	—	—	100	—	—	—	—	—	—	—	
Type 1 Combination (600V)	[A]	35 kA Available Fault Current											
		—	—	—	—	125	125	—	—	250	—	—	
Type 1 Combination (600V)	[A]	50 kA Available Fault Current											
		—	—	—	—	—	—	—	—	—	—	250	250

Table 38 - Coil Data

100/104-E, 100S/104S-E			9	12	16	26	30	38	40	52	65	80	96	
Operating Limits														
50/60Hz	pick-up	[x Us]	0.85...1.1											
	dropout	[x Us]	≤ 0.60											
DC Control	pick-up	[x Us]	0.80...1.1											
	dropout	[x Us]	≤ 0.60											
Standard Coil														
24-60V AC, 20-60V DC (KJ)	pick-up	[VA]/[W]	50/50					25/25			40/40			
	hold-in	[VA]/[W]	2.2/2					4/2			4/2			
48...130V AC/DC (KY)	pick-up	[VA]/[W]	50/50					25/25			40/40			
	hold-in	[VA]/[W]	2.2/2					4/2			4/2			
100...250V AC/DC (KD)	pick-up	[VA]/[W]	50/50					25/25			40/40			
	hold-in	[VA]/[W]	2.2/2					4/2			4/2			
250...500V AC/DC (KN)	pick-up	[VA]/[W]	50/50					25/25			40/40			
	hold-in	[VA]/[W]	2.2/2					4/2			4/2			
Operating Times	closing delay	[ms]	40...95					42...100						
	opening delay	[ms]	11...95					17...100						
Energy-efficient Coil														
12-20V DC (EQ)	pick-up	[W]	12...16					—	—	—	—	—	—	—
	hold-in	[W]	1.7					—	—	—	—	—	—	—
24-60V AC, 20-60V DC (EJ)	pick-up	[VA]/[W]	16/12...16					—	—	—	—	—	—	—
	hold-in	[VA]/[W]	1.7/1.7					—	—	—	—	—	—	—
Operating Times	closing delay	[ms]	40...95					—	—	—	—	—	—	—
	opening delay	[ms]	11...95					—	—	—	—	—	—	—
High Energy Efficient Coil														
24V DC (QJ)	pick-up	[W]	6					—	—	—	—	—	—	—
	hold-in	[W]	1.7					—	—	—	—	—	—	—
Operating Times	closing delay	[ms]	27...53					—	—	—	—	—	—	—
	opening delay	[ms]	17...29					—	—	—	—	—	—	—

116...2650 A Contactors

Table 39 - Main Circuits

100/104-E, 100S-E		116	146	190	205	265	305	370	400	460	580	750	860	1060	1260	2050	2650	
AC-1 Active Power Load (50/60 Hz); Ambient temperature 40 °C (104 °F)																		
Rated Operational Current, I_e	690V	[A]	160	225	275	350	400	500	600	600	700	800	1050	1350	1650	1260	2050	2650
	1000V	[A]	160	225	250	275	350	375	400	600	700	800	1050	1350	1650	1260	2050	2650
Rated Operational Power, P_e	230V	[kW]	64	90	110	139	159	199	239	239	279	319	418	538	657	502	817	1056
	240V	[kW]	67	94	114	145	166	208	249	249	291	333	436	561	686	524	852	1102
	400V	[kW]	111	156	191	242	277	346	416	416	485	554	727	935	1143	873	1420	1836
	415V	[kW]	115	162	198	252	288	359	431	431	503	575	755	970	1186	906	1474	1905
	500V	[kW]	139	195	238	303	346	433	520	520	606	693	909	1169	1429	1091	1775	2295
	690V	[kW]	191	269	329	418	478	598	717	717	837	956	1255	1613	1972	1506	2450	3167
	1000V	[kW]	277	390	433	476	606	650	693	1039	1212	1386	1819	2338	2858	2182	3551	4590
Ambient temperature 60 °C (140 °F)																		
Rated Operational Current, I_e	690V	[A]	145	200	250	300	350	400	500	500	600	700	875	1150	1450	1040	1750	2350
	1000V	[A]	145	200	225	250	300	325	350	500	600	700	875	1150	1450	1040	1750	2350
Rated Operational Power, P_e	230V	[kW]	58	80	100	120	139	159	199	199	239	279	349	458	578	414	697	936
	240V	[kW]	60	83	104	125	145	166	208	208	249	291	364	478	603	432	727	977
	400V	[kW]	100	139	173	208	242	277	346	346	416	485	606	797	1005	721	1212	1628
	415V	[kW]	104	144	180	216	252	288	359	359	431	503	629	827	1042	748	1258	1689
	500V	[kW]	126	173	217	260	303	346	433	433	520	606	758	996	1256	901	1516	2035
	690V	[kW]	173	239	299	359	418	478	598	598	717	837	1046	1374	1733	1243	2091	2809
	1000V	[kW]	251	346	390	433	520	563	606	866	1039	1212	1516	1992	2511	1801	3031	4070
Ambient temperature 70 °C (158 °F)																		
Rated Operational Current, I_e	690V	[A]	130	175	200	240	290	325	400	400	480	580	720	1000	1270	875	1500	2120
	1000V	[A]	130	175	185	200	240	260	290	400	480	580	720	1000	1270	875	1500	2120
Rated Operational Power, P_e	230V	[kW]	52	70	80	96	116	129	159	159	191	231	287	398	506	349	598	845
	240V	[kW]	54	73	83	100	121	135	166	166	200	241	299	416	528	364	624	881
	400V	[kW]	90	121	139	166	201	225	277	277	333	402	499	693	880	606	1039	1469
	415V	[kW]	93	126	144	173	208	234	288	288	345	417	518	719	913	629	1078	1524
	500V	[kW]	113	152	173	208	251	281	346	346	416	502	624	866	1100	758	1299	1836
	690V	[kW]	155	209	239	287	347	388	478	478	574	693	860	1195	1518	1046	1793	2534
	1000V	[kW]	225	303	320	346	416	450	502	693	831	1005	1247	1732	2200	1516	2598	3672
With conductor sizes	[mm ²]	70	95	150	240 ⁽¹⁾	240	300 ⁽²⁾	2x185 ⁽²⁾	2x185	2x240	2x240	800 ⁽³⁾	1000 ⁽⁴⁾	1500 ⁽⁴⁾	1000 ⁽³⁾	2000 ⁽⁴⁾	3000 ⁽⁴⁾	

(1) For currents above 275 A, use terminal extensions.
 (2) For currents above 450 A, use terminal extensions.
 (3) Maximum connection bar width 50 mm.
 (4) Maximum connection bar width 100 mm.

Table 40 - Main Circuits

100/104-E, 100S-E			116	146	190	205	265	305	370	400	460	580	750	860	1060	1260	2050	2650
Switching of 3-phase Motors: (50 Hz) Ambient temperature 60 °C (140 °F) AC-2, AC-3																		
Rated Operational Current, I_e	220-240V	[A]	116	146	190	205	265	305	370	400	460	580	750	860	1060	—	—	—
	380-400V	[A]	116	146	190	205	265	305	370	400	460	580	750	860	1060	—	—	—
	415V	[A]	116	146	190	205	265	305	370	400	460	580	750	860	1060	—	—	—
	440V	[A]	116	146	190	205	265	305	370	400	460	580	750	860	1060	—	—	—
	500V	[A]	110	130	156	185	250	290	350	400	460	580	750	860	970	—	—	—
	690V	[A]	66	93	135	165	250	290	315	350	400	500	650	800	970	—	—	—
	1000V	[A]	46	60	85	100	113	131	141	155	200	250	300	375	400	—	—	—
Rated Operational Power, P_e	220-240V	[kW]	37	45	55	55	75	90	110	110	132	160	220	250	315	—	—	—
	380-400V	[kW]	55	75	90	110	132	160	200	200	250	315	400	475	560	—	—	—
	415V	[kW]	55	75	90	110	132	160	200	220	250	355	425	500	630	—	—	—
	440V	[kW]	75	90	110	132	160	160	200	220	250	355	450	560	710	—	—	—
	500V	[kW]	75	90	110	132	160	200	250	250	315	400	530	630	710	—	—	—
	690V	[kW]	63	90	132	160	200	250	315	315	355	500	600	800	1000	—	—	—
	1000V	[kW]	55	75	110	132	160	185	200	220	280	355	400	555	600	—	—	—
Load Carrying Capacity per UL/CSA																		
General-purpose Current (enclosed)		[A]	160	200	250	300	350	400	520	550	650	750	900	1350	1650	1210	2100	2700
Rated Operational Current and Power (enclosed), 3-Phase	200V	[A]	92	120	150	177	221	285	359	359	414	552	692	954	1030	—	—	—
	230V	[A]	104	130	154	192	248	312	360	360	480	604	722	954	1030	—	—	—
	460V	[A]	96	124	156	180	240	302	361	414	477	590	722	954	1030	—	—	—
	575V	[A]	99	125	144	192	242	289	336	382	472	578	672	944	1050	—	—	—
	200V	[Hp]	30	40	50	60	75	100	125	125	150	200	250	—	—	—	—	—
	230V	[Hp]	40	50	60	75	100	125	150	150	200	250	300	400	450	—	—	—
	460V	[Hp]	75	100	125	150	200	250	300	350	400	500	600	800	900	—	—	—
	575V	[Hp]	100	125	150	200	250	300	350	400	500	600	700	1000	1150	—	—	—
Rated Current (enclosed), with 3 poles in series	260V DC	[A]	160	200	—	—	—	—	—	—	—	—	—	—	—	—	—	—
	300V DC	[A]	—	—	230	250	—	—	—	—	—	—	—	—	—	—	—	—
	340V DC	[A]	—	—	—	—	350	400	520	—	—	—	—	—	—	—	—	—
	600V DC	[A]	—	—	—	—	—	—	—	550	650	750	900	1050	1350	1210	1900	—

Table 41 - Main Circuits

100/104-E, 100S-E			116	146	190	205	265	305	370	400	460	580	750	860	1060	1260	2050	2650
Switching of 3-phase Motors, (50Hz); Ambient temperature 60°C, AC-4																		
Rated Operational Current, I_e	230V	[A]	84	103	128	156	195	230	280	307	377	-	-	-	-	-	-	-
	240V	[A]	84	103	128	156	195	230	280	307	377	-	-	-	-	-	-	-
	400V	[A]	84	103	128	156	195	230	280	307	377	-	-	-	-	-	-	-
	415V	[A]	84	103	128	156	195	230	280	307	377	-	-	-	-	-	-	-
	500V	[A]	84	103	128	156	195	230	280	307	377	-	-	-	-	-	-	-
	690V	[A]	66	80	93	104	153	162	188	334	350	-	-	-	-	-	-	-
	1000V	[A]	40	48	72	85	90	95	100	141	155	-	-	-	-	-	-	-
Rated Operational Power, P_e	230V	[kW]	25	32	40	50	55	75	90	90	110	-	-	-	-	-	-	-
	240V	[kW]	25	32	40	50	63	75	90	100	125	-	-	-	-	-	-	-
	400V	[kW]	45	55	63	80	110	132	160	160	200	-	-	-	-	-	-	-
	415V	[kW]	45	55	63	90	110	132	160	160	220	-	-	-	-	-	-	-
	500V	[kW]	55	63	90	110	132	160	200	220	250	-	-	-	-	-	-	-
	690V	[kW]	63	75	90	100	150	160	185	315	335	-	-	-	-	-	-	-
	1000V	[kW]	55	63	100	110	125	132	132	200	220	-	-	-	-	-	-	-
AC-4 at approximately 200,000 operations																		
Rated Operational Current, I_e	230V	[A]	38	38	49	55	73	89	100	118	135	-	-	-	-	-	-	-
	240V	[A]	38	38	49	55	73	89	100	118	135	-	-	-	-	-	-	-
	400/415V	[A]	38	38	49	55	73	89	100	118	135	-	-	-	-	-	-	-
	500V	[A]	33	33	37	44	53	59	68	78	89	-	-	-	-	-	-	-
	690V	[A]	33	33	37	44	53	59	68	78	89	-	-	-	-	-	-	-
	1000V	[A]	-	-	-	-	-	-	-	-	-	-	-	-	-	-	-	-
	Rated Operational Power, P_e	230V	[kW]	11	11	13	15	22	25	30	37	40	-	-	-	-	-	-
240V		[kW]	11	11	15	15	22	25	32	37	45	-	-	-	-	-	-	-
400V		[kW]	20	20	25	30	40	50	55	63	75	-	-	-	-	-	-	-
415V		[kW]	20	20	25	30	40	50	55	63	75	-	-	-	-	-	-	-
500V		[kW]	22	22	25	30	37	40	45	55	63	-	-	-	-	-	-	-
690V		[kW]	30	30	32	40	50	55	63	75	80	-	-	-	-	-	-	-
1000V		[kW]	-	-	-	-	-	-	-	-	-	-	-	-	-	-	-	-
Max. switching frequency	Ops/h	150	150	150	150	150	150	150	60	60	-	-	-	-	-	-	-	
Wye-Delta (60 Hz)																		
Rated Operational Power, P_e	200V	[Hp]	50	60	75	100	125	150	200	200	250	-	-	-	-	-	-	-
	230V	[Hp]	60	75	100	125	150	200	250	250	350	450	500	-	-	-	-	-
	460V	[Hp]	125	150	200	250	350	450	500	500	600	800	-	-	-	-	-	-
	575V	[Hp]	150	200	250	300	450	500	600	600	700	1000	-	-	-	-	-	-

Table 42 - Main Circuits

100/104-E, 100S-E			116	146	190	205	265	305	370	400	460	580	750	860	1060	1260	2050	2650	
UL/CSA Elevator Duty																			
Rated Operational Current, I_e	200V	[A]	54	54	77	99	125	149	156	—	—	—	—	—	—	—	—	—	—
	230V	[A]	54	54	77	99	125	149	156	—	—	—	—	—	—	—	—	—	—
	460V	[A]	54	54	77	99	125	149	156	—	—	—	—	—	—	—	—	—	—
	575V	[A]	54	54	77	99	125	149	156	—	—	—	—	—	—	—	—	—	—
Rated Operational Power, P_e	200V	[Hp]	15	15	20	30	40	40	50	—	—	—	—	—	—	—	—	—	—
	230V	[Hp]	20	20	25	30	40	50	60	—	—	—	—	—	—	—	—	—	—
	460V	[Hp]	40	40	60	75	100	100	125	—	—	—	—	—	—	—	—	—	—
	575V	[Hp]	50	50	75	100	125	150	150	—	—	—	—	—	—	—	—	—	—
UL/CSA HVAC Applications																			
Definite purpose rating (3-phase)																			
FLA	600V	[A]	116	160	200	250	300	350	520	—	—	—	—	—	—	—	—	—	—
LRA	230V	[A]	700	960	1200	1500	1800	2100	3120	—	—	—	—	—	—	—	—	—	—
	460V	[A]	580	800	1000	1250	1500	1750	2600	—	—	—	—	—	—	—	—	—	—
	575V	[A]	470	640	800	1000	1200	1400	2080	—	—	—	—	—	—	—	—	—	—
AC resistance heating	600V	[A]	160	200	250	300	400	450	520	—	—	—	—	—	—	—	—	—	—
Star-Delta Starting (50 Hz)																			
Rated Operational Current, I_e	≤ 230V	[A]	200	252	329	355	458	528	640	692	796	1004	1299	1489	1835	—	—	—	—
	≤ 240V	[A]	200	252	329	355	458	528	640	692	796	1004	1299	1489	1835	—	—	—	—
	400V	[A]	200	252	329	355	458	528	640	692	796	1004	1299	1489	1835	—	—	—	—
	415V	[A]	200	252	329	355	458	528	640	692	796	1004	1299	1489	1835	—	—	—	—
	500V	[A]	190	225	233	285	433	502	545	692	796	1004	1299	1385	1680	—	—	—	—
	690V	[A]	112	161	233	285	433	502	545	606	692	866	1125	1385	1680	—	—	—	—
	1000V	[A]	—	103	147	173	173	173	173	268	346	433	519	—	—	—	—	—	—
Rated Operational Power, P_e	230V ⁽¹⁾	[kW]	55	75	90	110	132	160	200	200	250	315	400	500	560	—	—	—	—
	240V ⁽¹⁾	[kW]	55	75	110	110	132	160	200	200	250	315	400	500	630	—	—	—	—
	400V ⁽¹⁾	[kW]	110	132	160	200	250	250	355	400	400	560	710	800	1000	—	—	—	—
	415V ⁽¹⁾	[kW]	110	132	160	200	250	315	355	400	400	560	800	900	1100	—	—	—	—
	500V ⁽¹⁾	[kW]	132	160	160	200	315	355	355	500	500	710	800	1000	1300	—	—	—	—
	690V ⁽¹⁾	[kW]	90	132	200	250	400	500	500	560	710	800	1100	1400	1700	—	—	—	—
	1000V ⁽¹⁾	[kW]	—	132	200	250	250	250	250	355	500	630	710	—	—	—	—	—	—

(1) Power ratings at 50 Hz: Preferred values according to IEC 60947-4-1.

Table 43 - Main Circuits

100/104-E, 100S-E		116	146	190	205	265	305	370	400	460	580	750	860	1060	1260	2050	2650	
Switching of Power Transformers, AC-6a (50 Hz)																		
Inrush Current _____ = n																		
Rated transformer current																		
n = 30	≥ 230V	[A]	70	79	111	115	143	165	200	252	263	286	430	524	362	—	—	—
	≥ 240V	[A]	70	79	111	115	143	165	200	252	263	286	430	524	362	—	—	—
	≥ 400V	[A]	70	79	111	115	143	165	200	252	263	286	430	524	362	—	—	—
	≥ 415V	[A]	70	79	111	115	143	165	200	252	263	286	430	524	362	—	—	—
	≥ 500V	[A]	70	79	111	115	143	165	200	252	263	286	—	—	362	—	—	—
	≥ 690V	[A]	70	79	111	115	143	165	200	252	263	286	—	—	362	—	—	—
	≥ 1000V	[A]	—	—	—	—	—	—	—	—	—	—	—	—	—	—	—	—
Apparent Power	230V	[kVA]	28	31	44	46	57	66	80	100	105	114	171	209	144	—	—	—
	240V	[kVA]	29	33	46	48	59	69	83	105	109	119	179	218	150	—	—	—
	400V	[kVA]	48	55	77	80	99	114	139	175	182	198	298	363	251	—	—	—
	415V	[kVA]	50	56	79	82	102	117	142	179	187	203	305	372	257	—	—	—
	500V	[kVA]	61	68	96	100	124	143	173	218	228	248	—	—	314	—	—	—
	690V	[kVA]	84	94	133	137	171	197	239	301	314	342	—	—	433	—	—	—
n = 20	≥ 690V	[A]	105	119	167	173	215	248	300	378	395	429	—	—	543	—	—	—
n = 15	≥ 690V	[A]	140	158	222	230	286	330	400	504	526	572	—	—	724	—	—	—
60 Hz Peak Inrush/peak rated transformer current																		
n = 30	≥ 660V	[A]	70	79	111	115	143	165	200	252	263	286	430	524	362	—	—	—
Apparent Power	200V	[kVA]	24	27	38	40	50	57	69	87	91	99	149	182	125	—	—	—
	208V	[kVA]	25	28	40	41	52	59	72	91	95	103	155	189	130	—	—	—
	240V	[kVA]	29	33	46	48	59	69	83	105	109	119	179	218	150	—	—	—
	480V	[kVA]	58	66	92	96	119	137	166	210	219	238	357	436	301	—	—	—
	600V	[kVA]	73	82	115	120	149	171	208	262	273	297	447	545	376	—	—	—
	660V	[kVA]	80	90	127	131	163	189	229	288	301	327	492	599	414	—	—	—
n = 20	≥ 660V	[A]	105	119	167	173	215	248	300	378	395	429	645	786	543	—	—	—
Apparent Power	200V	[kVA]	36	41	58	60	74	86	104	131	137	149	223	272	188	—	—	—
	208V	[kVA]	38	43	60	62	77	89	108	136	142	155	232	283	196	—	—	—
	240V	[kVA]	44	49	69	72	89	103	125	157	164	178	268	327	226	—	—	—
	480V	[kVA]	87	99	139	144	179	206	249	314	328	357	536	653	451	—	—	—
	600V	[kVA]	109	124	174	180	223	258	312	393	410	446	670	817	564	—	—	—
	660V	[kVA]	120	136	191	198	246	284	343	432	452	490	737	899	621	—	—	—
n = 15	≥ 660V	[A]	140	158	222	230	286	330	400	504	526	572	860	1048	724	—	—	—
Apparent Power	200V	[kVA]	48	55	77	80	99	114	139	175	182	198	298	363	251	—	—	—
	208V	[kVA]	50	57	80	83	103	119	144	182	190	206	310	378	261	—	—	—
	240V	[kVA]	58	66	92	96	119	137	166	210	219	238	357	436	301	—	—	—
	480V	[kVA]	116	131	185	191	238	274	333	419	437	476	715	871	602	—	—	—
	600V	[kVA]	145	164	231	239	297	343	416	524	547	594	894	1089	752	—	—	—
	660V	[kVA]	160	181	254	263	327	377	457	576	601	654	983	1198	828	—	—	—

Table 44 - Main Circuits

100/104-E, 100S-E			116	146	190	205	265	305	370	400	460	580	750	860	1060	1260	2050	2650
Switching of 3-phase Capacitors, AC-6b (50 Hz)																		
Single capacitor 40 °C	230V	[kVAR]	40	50	60	75	85	100	110	120	140	170	220	250	300	–	–	–
	240V	[kVAR]	40	50	60	75	85	100	110	120	140	170	220	250	300	–	–	–
	400V	[kVAR]	75	90	110	130	145	165	200	210	240	285	400	450	500	–	–	–
	415V	[kVAR]	75	90	110	130	145	165	200	210	240	285	400	450	500	–	–	–
	500V	[kVAR]	83	110	140	160	180	210	240	260	325	350	490	550	600	–	–	–
	690V	[kVAR]	80	110	135	170	200	240	280	300	325	440	600	650	800	–	–	–
	1000V	[kVAR]	–	100	140	150	155	160	170	250	300	350	450	–	–	–	–	–
Single capacitor 55 °C	230V	[kVAR]	40	50	60	75	85	100	110	120	140	170	220	250	300	–	–	–
	240V	[kVAR]	40	50	60	75	85	100	110	120	140	170	220	250	300	–	–	–
	400V	[kVAR]	75	90	110	130	145	165	200	210	240	285	400	450	500	–	–	–
	415V	[kVAR]	75	90	110	130	145	165	200	210	240	285	400	450	500	–	–	–
	500V	[kVAR]	83	110	140	160	180	210	240	260	325	350	490	550	600	–	–	–
	690V	[kVAR]	80	110	135	170	200	240	280	300	325	440	600	650	800	–	–	–
	1000V	[kVAR]	–	100	140	150	155	160	170	250	300	350	450	–	–	–	–	–
Single capacitor 70 °C	230V	[kVAR]	35	42	45	57	70	85	100	105	120	160	190	230	280	–	–	–
	240V	[kVAR]	35	42	45	57	70	85	100	105	120	160	190	230	280	–	–	–
	400V	[kVAR]	65	74	83	105	135	155	180	195	225	275	370	430	480	–	–	–
	415V	[kVAR]	65	74	83	105	135	155	180	195	225	275	370	430	480	–	–	–
	500V	[kVAR]	78	96	102	130	165	196	220	241	300	340	435	530	570	–	–	–
	690V	[kVAR]	75	110	135	160	200	240	260	300	325	440	600	630	750	–	–	–
	1000V	[kVAR]	–	95	120	130	140	150	160	220	270	300	400	–	–	–	–	–
60 Hz Single Capacitor (cULus)																		
Single capacitor 40 °C	208V	[kVAR]	33	41	50	67	83	100	125	119	142	178	214	–	346	–	–	–
	240V	[kVAR]	38	48	57	77	95	115	144	137	164	205	247	–	398	–	–	–
	480V	[kVAR]	75	100	125	150	200	250	300	274	329	411	494	–	832	–	–	–
	600V	[kVAR]	100	125	150	200	250	300	350	343	410	514	618	–	1040	–	–	–
Switching of Lamps																		
Gas discharge lamps AC-5a	open	[A]	116	146	190	205	265	305	370	400	460	580	750	877	1072	812	1332	1722
UL Ballast Ratings		[A]	160	200	250	300	400	450	520	–	–	–	–	–	–	–	–	–
Filament AC-5b	230/ 240V	[A]	116	146	190	205	265	305	370	400	460	580	750	877	1072	812	1332	1722

Table 45 - Main Circuits

100/104-E, 100S-E		116	146	190	205	265	305	370	400	460	580	750	860	1060	1260	2050	2650	
Switching of DC Loads—Non-inductive or slightly inductive loads or resistance furnaces DC-1 at 60 °C																		
1 pole	≤ 72V	[A]	160	200	250	350	400	500	520	600	700	800	1050	1350	1650	1250	2050	—
	90V	[A]	160	200	250	350	400	500	520	—	—	—	—	—	—	—	—	—
	100V	[A]	—	—	250	350	400	500	520	—	—	—	—	—	—	—	—	—
	110V	[A]	—	—	—	—	400	500	520	600	700	800	1050	1350	1650	1250	2050	—
2 poles in series	≤ 72V	[A]	160	200	250	350	400	500	520	600	700	800	1050	1350	1650	1250	2050	—
	110V	[A]	160	200	250	350	400	500	520	600	700	800	1050	1350	1650	1250	2050	—
	175V	[A]	160	200	250	350	400	500	520	600	700	800	1050	—	—	—	—	—
	200V	[A]	—	—	250	350	400	500	520	600	700	800	1050	—	—	—	—	—
3 poles in series	≤ 72V	[A]	160	200	250	350	400	500	520	600	700	800	1050	1350	1650	1250	2050	—
	110V	[A]	160	200	250	350	400	500	520	600	700	800	1050	1350	1650	1250	2050	—
	175V	[A]	160	200	250	350	400	500	520	600	700	800	1050	1350	1650	1250	2050	—
	220V	[A]	160	200	250	350	400	500	520	600	700	800	1050	1350	1650	1250	2050	—
	260V	[A]	160	200	250	350	400	500	520	600	700	800	1050	1350	1650	1250	2050	—
	300V	[A]	—	—	250	350	400	500	520	600	700	800	1050	1350	1650	1250	2050	—
	340V	[A]	—	—	—	—	400	500	520	600	700	800	1050	1350	1650	1250	2050	—
	600V	[A]	—	—	—	—	—	—	—	600	700	800	1050	1350	1650	1250	2050	—
850V	[A]	—	—	—	—	—	—	—	—	—	800	1050	1350	1650	1250	2050	—	
Shunt-wound Motors—Starting, reverse current breaking, reversing, stepping DC-3, 60 °C (L/R ≤ 2 ms)																		
3 poles in series	24V	[A]	145	160	250	275	350	400	450	600	700	800	1050	—	—	—	—	—
	48/60V	[A]	145	160	250	275	350	400	450	600	700	800	1050	—	—	—	—	—
	110V	[A]	145	160	250	275	350	400	450	600	700	800	1050	—	—	—	—	—
	220V	[A]	145	160	250	275	350	400	450	600	700	800	1050	—	—	—	—	—
	600V	[A]	—	—	—	—	—	—	—	600	700	800	1050	—	—	—	—	—
Series-wound Motors—Starting, reverse current breaking, reversing, stepping DC-5, 60 °C (L/R ≤ 7.5 ms)																		
3 poles in series	24V	[A]	145	160	250	275	350	400	450	600	700	800	1050	—	—	—	—	—
	48/60V	[A]	145	160	250	275	350	400	450	600	700	800	1050	—	—	—	—	—
	110V	[A]	145	160	250	275	350	400	450	600	700	800	1050	—	—	—	—	—
	220V	[A]	145	160	250	275	350	400	450	600	700	800	1050	—	—	—	—	—
	600V	[A]	—	—	—	—	—	—	—	600	700	800	1050	—	—	—	—	—
Short Time Withstand I_{cw}																		
40 °C	1 s	[A]	1300	1460	1900	2050	2650	3050	3700	4600	4600	7000	7000	10000	12000	8000	12000	12000
	10 s	[A]	928	1168	1520	1640	2120	2440	2960	4400	4400	6400	6400	8000	10000	7200	10000	10000
	30 s	[A]	536	674	878	947	1224	1409	1709	3100	3100	4500	4500	6000	7500	5200	7500	7500
	1 min	[A]	379	477	621	670	865	996	1208	2500	2500	3500	3500	4500	5500	4000	5500	5500
	15 min	[A]	160	225	275	350	400	500	600	840	840	1300	1300	1600	2200	1500	2200	2800
Resistance and Power Dissipation																		
Main current circuit resistance		[mΩ]	0.469	0.454	0.198	0.204	0.200	0.200	0.200	0.083	0.086	0.050	0.045	0.044	0.029	0.050	0.030	0.028
Power dissipation per pole at I _e AC-1, 400V		[W]	12	23	15	25	32	50	72	30	42	32	50	80	80	80	125	200
Power dissipation per pole at I _e AC-3/ 400V		[W]	6	10	7	8	14	19	27	16	21	17	28	50	50	—	—	—
Total power dissipation at:																		
I _e AC-3, 400V; AC/DC control (120-250V)		[W]	21	33	23.5	26.5	46.5	61.5	85.5	53	68	56	89	171	171	—	—	—
Maximum Switching Frequency	AC-1	ops/hr	300						300						60	300	60	15
	AC-3	ops/hr	300						300						60	—	—	—
	AC-2, AC-4	ops/hr	150						60						60	—	—	—
Lifespan, mechanical		[Million ops.]	5	5	5	5	5	5	5	3	3	3	3	0.5	0.5	0.5	0.5	0.3

Table 45 - Main Circuits (Continued)

100/104-E, 100S-E		116	146	190	205	265	305	370	400	460	580	750	860	1060	1260	2050	2650
Weight																	
AC/DC (Electronic) with bar connections	kg (lbs.)	1.50 (3.3)	1.50 (3.3)	3 (6.6)	3 (6.6)	4.64 (10.2)	4.64 (10.2)	4.64 (10.2)	12 (26.4)	12 (26.4)	15 (33)	15 (33)	34 (74.8)	35 (77)	16 (35.2)	35 (77)	45 (99)
with built-in cable clamps	kg (lbs.)	1.75 (3.85)	1.75 (3.85)	-	-	-	-	-	-	-	-	-	-	-	-	-	-

Table 46 - Short-circuit Current Ratings

100/104-E, 100S-E		116	146	190	205	265	305	370	400	460	580	750	860	1060	1260	2050	2650	
Short Circuit Coordination (Max. Fuse or Circuit Breaker Rating) Per IEC 60947-4-1																		
DIN Fuses - gG	Type "2" (400V)	[A]	100 kA Available Fault Current															
			250	250	315	315	400	500	630	630	630	800	800	1000	1250	-	-	-
MCCB	Type "2" (690V)	[A]	80 kA Available Fault Current															
			160	200	315	315	400	425	500	500	630	800	800	1000	1600	-	-	-
MCCB	Type "2" (400V)	[A]	70 kA Available Fault Current															
			160	160	320	320	400	630	630	630	630	800	1000	1600	1600	-	-	-
Short Circuit Current Rating (Max. Fuse or Circuit Breaker Rating) Per UL 60947 and CSA 22.2 No. 14 (contactor and fuses or circuit breaker only)																		
UL Class RK5 Fuses	Type 1 Combination (600V)	[A]	10 kA Available Fault Current															
			250	250	400	400	-	-	-	-	-	-	-	-	-	-	-	-
UL Class L Fuses	Type 1 Combination (600V)	[A]	18 kA Available Fault Current															
			-	-	-	-	800	800	800	1000	-	-	-	-	-	-	-	-
	Type 1 Combination (600V)	[A]	30 kA Available Fault Current															
			-	-	-	-	-	-	-	1000	-	-	-	-	-	-	-	-
UL Class J and CSA HRCl-J Fuses	Type 1 Combination (600V)	[A]	85 kA Available Fault Current															
			-	-	-	-	-	-	-	-	-	-	1600	2000	-	-	-	
UL Class J and CSA HRCl-J Fuses	Type 1 Combination (600V)	[A]	100 kA Available Fault Current															
			250	250	400	400	600	600	600	600	600	-	-	-	-	-	-	-
UL Class L Fuses	Type 2 Combination (600V)	[A]	100 kA Available Fault Current															
			200	200	400	400	600	600	600	600	600	-	-	-	-	-	-	-
UL Class L Fuses	Type 1 Combination (600V)	[A]	100 kA Available Fault Current															
			-	-	-	-	-	-	-	800	800	1200	1200	-	-	1600	-	-
UL Class L Fuses	Type 2 Combination (600V)	[A]	100 kA Available Fault Current															
			-	-	-	-	-	-	-	-	-	1200	1200	-	-	-	-	-
UL Inverse- Time Circuit Breaker	Type 1 Combination (480V)	[A]	42 kA Available Fault Current															
			-	-	-	-	-	-	-	-	-	1200	1200	2000	2000	-	-	-
	Type 2 Combination (480V)	[A]	65 kA Available Fault Current															
			250	250	400	400	800	800	800	800	800	800	800	800	-	-	-	-
	Type 1 Combination (480V)	[A]	84 kA Available Fault Current															
			-	-	-	-	-	-	-	800	800	-	-	-	-	-	-	-
	Type 1 Combination (480V)	[A]	89 kA Available Fault Current															
			-	-	-	-	-	-	-	-	-	800	800	-	-	-	-	-
	Type 1 Combination (480V)	[A]	100 kA Available Fault Current															
			250	250	400	400	800	800	800	-	-	-	-	-	-	-	-	-
	Type 2 Combination (600V)	[A]	25 kA Available Fault Current															
			250	250	-	-	-	-	-	-	-	-	-	-	-	-	-	-
	Type 2 Combination (600V)	[A]	35 kA Available Fault Current															
			-	-	400	400	800	800	800	800	800	800	800	-	-	-	-	-
Type 1 Combination (600V)	[A]	42 kA Available Fault Current																
		-	-	-	-	800	800	800	800	800	800	800	-	-	-	-	-	
Type 1 Combination (600V)	[A]	50 kA Available Fault Current																
		250	250	-	-	-	-	-	-	-	-	-	-	-	-	-	-	
Type 1 Combination (600V)	[A]	65 kA Available Fault Current																
		-	-	400	400	400	400	400	-	-	-	-	-	-	-	-	-	

Table 47 - Coil Data

100/104-E, 100S-E			116	146	190	205	265	305	370	400	460	580	750	860	1060	1260	2050	2650	
Operating Limits																			
50/60 Hz	pick-up	[x U _s]	0.85...1.1																
	dropout	[x U _s]	0.55																
DC control	pick-up	[x U _s]	0.80...1.1																
	dropout	[x U _s]	0.55																
24...60V AC	pick-up	[VA]	225	165	475	—	—	—	—	—	—	—	—	—	—	—	—	—	—
	hold-in	[VA]	5.5	6	8.5	—	—	—	—	—	—	—	—	—	—	—	—	—	—
48...130V AC	pick-up	[VA]	170	175	340	1215	1100	—	1100	—	—	—	—	—	—	—	—	—	—
	hold-in	[VA]	4	4	17	12	12	—	12	—	—	—	—	—	—	—	—	—	—
100...250V AC	pick-up	[VA]	130	220	385	955	880	2450	880	2450	—	—	—	—	—	—	—	—	—
	hold-in	[VA]	6	7	17.5	12	12	48	12	48	—	—	—	—	—	—	—	—	—
250...500V AC	pick-up	[VA]	205	185	420	950	985	—	985	—	—	—	—	—	—	—	—	—	—
	hold-in	[VA]	16	16	21	12	12	—	12	—	—	—	—	—	—	—	—	—	—
24...60V DC	pick-up	[W]	210	205	400	900	785	—	785	—	—	—	—	—	—	—	—	—	—
	hold-in	[W]	2.5	2.5	3.5	5	5.5	—	5.5	—	—	—	—	—	—	—	—	—	—
48...130V DC	pick-up	[W]	130	130	360	1150	1020	—	1020	—	—	—	—	—	—	—	—	—	—
	hold-in	[W]	2.5	2.5	2.5	5	5	—	5	—	—	—	—	—	—	—	—	—	—
100...250V DC	pick-up	[W]	135	190	410	895	880	2290	880	2290	—	—	—	—	—	—	—	—	—
	hold-in	[W]	3	2.5	4.5	5	5	20.5	5	20.5	—	—	—	—	—	—	—	—	—
250...500V DC	pick-up	[W]	205	190	600	885	910	—	910	—	—	—	—	—	—	—	—	—	—
	hold-in	[W]	4	4	4.7	7.5	7.5	—	7.5	—	—	—	—	—	—	—	—	—	—
PLC Interface			10 mA @ 24V DC																
Operating Times																			
AC or DC	closing delay	[ms]	20...55	25...60	30...60	50...120	50...120	50...80	50...120	50...80	—	—	—	—	—	—	—	—	—
	opening delay	[ms]	40...70	45...80	45...80	33...70	33...70	35...55	33...70	35...55	—	—	—	—	—	—	—	—	—
With PLC Interface	closing delay	[ms]	20...31	25...45	25...45	40...60	40...90	40...65	40...90	40...65	—	—	—	—	—	—	—	—	—
	opening delay	[ms]	24...34	25...45	25...45	10...30	10...30	10...30	10...30	10...30	—	—	—	—	—	—	—	—	—

Conductors

Table 48 - Cross Sections, Screw Type Terminals

100/104-E, 100S/104S-E			9	12	16	26	30	38	40	52	65	80	96
Conductor Cross Sections—Main Contacts Terminal Type			(1)						(2)			(3)	
	1 conductor	[mm ²]	0.75...6	0.75...6	0.75...6	1.5...10	1.5...10	1.5...10	4...35	4...35	4...35	6...50	6...50
	2 conductors	[mm ²]	0.75...6	0.75...6	0.75...6	1.5...10	1.5...10	1.5...10	4...35	4...35	4...35	6...50	6...50
	1 conductor	[mm ²]	1...6	1...6	1...6	2.5...10	2.5...10	2.5...10	6...35	6...35	6...35	6...70	6...70
	2 conductors	[mm ²]	1...6	1...6	1...6	2.5...10	2.5...10	2.5...10	6...35	6...35	6...35	6...50	6...50
Recommended torque		[N·m]	1.5	1.5	1.5	2.5	2.5	2.5	4	4	4	6	6
Cross Section per UL/CSA		[AWG]	16...10	16...10	16...10	14...8	14...8	14...8	10...2	10...2	10...2	6...1	6...1
Recommended torque		[lb·in]	13	13	13	22	22	22	35	35	35	53	53
Conductor Cross Sections- Coil and Auxiliary Contact Terminal Type			(1)										
	1 conductor	[mm ²]	0.75...2.5	0.75...2.5	0.75...2.5	0.75...2.5	0.75...2.5	0.75...2.5	0.75...2.5	0.75...2.5	0.75...2.5	0.75...2.5	0.75...2.5
	2 conductors	[mm ²]	0.75...2.5	0.75...2.5	0.75...2.5	0.75...2.5	0.75...2.5	0.75...2.5	0.75...2.5	0.75...2.5	0.75...2.5	0.75...2.5	0.75...2.5
	1 conductor	[mm ²]	1...2.5	1...2.5	1...2.5	1...2.5	1...2.5	1...2.5	1...2.5	1...2.5	1...2.5	1...2.5	1...2.5
	2 conductors	[mm ²]	1...2.5	1...2.5	1...2.5	1...2.5	1...2.5	1...2.5	1...2.5	1...2.5	1...2.5	1...2.5	1...2.5
Recommended torque		[N·m]	1.2	1.2	1.2	1.2	1.2	1.2	1.2	1.2	1.2	1.2	1.2
Cross Section per UL/CSA		[AWG]	18...14	18...14	18...14	18...14	18...14	18...14	18...14	18...14	18...14	18...14	18...14
Recommended torque		[lb·in]	11	11	11	11	11	11	11	11	11	11	11

- (1) Pozidriv No. 2 / Blade No. 3 screw.
- (2) Pozidriv No. 2 / Blade No. 4 screw.
- (3) Hexagonal socket screw.

Table 49 - Cross Sections, Screw Type Terminals

100/104-E, 100S-E			116	146	190	205	265	305	370	400	460	580	750	860	1060	1260	2050	2650
Main Terminals																		
Conductor Cross Sections – Main Contacts (Terminal type)																		
	(1) conductor	[mm ²]	10...95	10...150	16...185	—	—	—	—	—	—	—	—	—	—	—	—	—
	Clamp Type		100-ECL146	100-ETL205	100-ETL370	—	—	—	—	—	—	—	—	—	—	—	—	—
Recommended torque		[N·m]	8	34	42	—	—	—	—	—	—	—	—	—	—	—	—	—
	(2) conductors	[mm ²]	10...95	—	16...500	70...240	70...240	120...240	70...300	—	—	—	—	—	—	—	—	—
	Clamp Type		100-ECL146	—	100-ETL370B	100-ETL580	100-ETL750	100-ETL860	100-ETL1060	—	—	—	—	—	—	—	—	—
Recommended torque		[N·m]	8	—	42	31	43	43	57	—	—	—	—	—	—	—	—	—
	(3) conductors	[mm ²]	—	—	—	—	—	70...500	120...500	70...750	70...240	—	—	—	—	—	—	—
	Clamp Type		—	—	—	—	—	100-ETL750	100-ETL860	100-ETL1060	100-ETL750	—	—	—	—	—	—	—
Recommended torque		[N·m]	—	—	—	—	—	43	43	57	43	—	—	—	—	—	—	—
	(4) conductors	[mm ²]	—	—	—	—	—	—	—	120...500	70...750	—	—	—	—	—	—	—
	Clamp Type		—	—	—	—	—	—	—	100-ETL860	100-ETL1060	—	—	—	—	—	—	—
Recommended torque		[N·m]	—	—	—	—	—	—	—	43	57	—	—	—	—	—	—	—
	(6) conductors	[mm ²]	—	—	—	—	—	—	—	—	—	—	—	70...750	—	—	—	—
	Clamp Type		—	—	—	—	—	—	—	—	—	—	—	100-ETL1060B	—	—	—	—
Recommended torque		[N·m]	—	—	—	—	—	—	—	—	—	—	—	57	—	—	—	—



Table 49 - Cross Sections, Screw Type Terminals (Continued)

100/104-E, 100S-E		116	146	190	205	265	305	370	400	460	580	750	860	1060	1260	2050	2650	
	L max.	[mm]	22	24		32			47	50			100		50		100	
	Ø min.	[mm]	6	8		10			10	12			12		12		12	
Recommended torque		[N•m]	9	18		28			35	45			45		45		45	
Cross section per UL/CSA																		
	(1) conductor	[AWG]	6...3/0	6...300 ⁽¹⁾	4...400 ⁽¹⁾													
	Clamp Type		100-ECL146	100-ETL205	100-ETL370													
Recommended torque		[lb•in]	80	300	375													
	(2) conductors	[AWG]	6...3/0		4...500 ⁽¹⁾	2/0...500 ⁽¹⁾	2/0...500 ⁽¹⁾	4/0...500 ⁽¹⁾	1/0...750 ⁽¹⁾	2/0...500 ⁽¹⁾								
	Clamp Type		100-ECL146		100-ETL370B	100-ETL580	100-ETL750	100-ETL860	100-ETL1060	100-ETL750								
Recommended torque		[lb•in]	80		375	275	375	375	500	375								
	(3) conductors	[AWG]					2/0...500 ⁽¹⁾	4/0...500 ⁽¹⁾	1/0...750 ⁽¹⁾	2/0...500 ⁽¹⁾								
	Clamp Type						100-ETL750	100-ETL860	100-ETL1060	100-ETL750								
Recommended torque		[lb•in]					375	375	500	375								
	(4) conductors	[AWG]						4/0...500 ⁽¹⁾	1/0...750 ⁽¹⁾									
	Clamp Type							100-ETL860	100-ETL1060									
Recommended torque		[lb•in]						375	500									
	(6) conductors	[AWG]							1/0...750 ⁽¹⁾									
	Clamp Type								100-ETL1060B									
Recommended torque		[lb•in]							500									
	L max.	[in]	0.866	0.945	1.26	1.85	1.97		3.94				1.97		3.94			
	Ø min.	[in]	0.236	0.315	0.394	0.394	0.472		0.472				0.472		0.472		0.472	
Recommended torque		[lb•in]	80	160	248	310	398		398				398		398		398	
Conductor Cross Sections – Coil and Auxiliary Contact Terminals (Terminal Type)																		
	(1) conductor	[mm ²]											0.75...2.5					
	(2) conductors	[mm ²]											0.75...2.5					
	(1) conductor	[mm ²]											1...4					
	(2) conductors	[mm ²]											1...4					
Recommended torque		[N•m]											1...1.2					
Cross section per UL/CSA		[AWG]											18...14					
Recommended torque		[lb•in]											8.9...10.6					

(1) MCM.

Auxiliary Contacts

Table 50 - Auxiliary Contacts

			Auxiliary contact for 100/100S/104-E09...E96				Auxiliary contact for 100/100S/104-E16...E2650		
			Internal 100-E09...E16	100-EF/ESA*/ ESB*	Low-power 100-ESA*B/B3	Low-power 100-ESA*B2/B4	100-ES1/2*	100-ES3/4*	Low-power 100-ES*-B*
Switching of AC Loads									
Rated Insulation voltage U_i			690V	690V	250V	250V	690V	690V	250V
Rated operational voltage U_e			690V	690V	125V	250V	690V	690V	125V
Rated impulse withstand voltage U_{imp}			6kV	6kV	—	—	6kV	6kV	1.5kV
AC-12 I_{th}	at 40 °C	[A]	16	16	0.1	2	16	16	0.1
	at 60 °C	[A]	—	—	—	—	—	—	—
AC-14 at rated voltage of	24V	[A]	—	—	0.1	—	—	—	0.1
	42/48V	[A]	—	—	0.1	—	—	—	0.1
	120V	[A]	—	—	0.1	—	—	—	0.1
AC-15 at rated voltage of	24V	[A]	6	6	—	2	6	6	—
	42/48V	[A]	6	6	—	2	6	6	—
	120V	[A]	6	6	—	2	6	6	—
	230V	[A]	4	4	—	2	4	4	—
	240V	[A]	4	4	—	2	4	4	—
	400V	[A]	3	3	—	—	3	3	—
	415V	[A]	3	3	—	—	3	3	—
500V	[A]	2	2	—	—	2	2	—	
690V	[A]	2	2	—	—	2	2	—	
Switching of DC Loads									
DC-12 L/R < 1 ms resistive loads at	24V DC	[A]	—	—	0.1	2	—	—	0.1
	48V DC	[A]	—	—	0.1	1	—	—	0.1
	110V DC	[A]	—	—	0.1	0.2	—	—	0.1
	220V DC	[A]	—	—	—	0.1	—	—	—
	440V DC	[A]	—	—	—	—	—	—	—
DC-14 L/R < 15 ms inductive loads with economy resistor in series at	24V DC	[A]	—	—	—	—	—	—	—
	48V DC	[A]	—	—	—	—	—	—	—
	110V DC	[A]	—	—	—	—	—	—	—
	220V DC	[A]	—	—	—	—	—	—	—
	440V DC	[A]	—	—	—	—	—	—	—
DC-13 switching electromagnets at	24V DC	[A]	6	6	—	—	3	6	—
	48V DC	[A]	2.8	2.8	—	—	1.5	2.8	—
	110V DC	[A]	0.55	0.55	—	—	0.55	0.55	—
	220V DC	[A]	0.27	0.27	—	—	0.3	0.3	—
	440V DC	[A]	0.13	0.13	—	—	—	—	—
Fuse gG									
Short-circuit protection with no welding of contacts per IEC 60947-5-2		[A]	10	10	0.1	10	10	10	0.1
		[A]	10	10	0.1	10	10	10	0.1
Protective Separation per IEC 60947-1, Annex N									
Min. switching capacity at 12V IEC 60947-5-4	[mA]	3	3	—	—	50	50	—	—
Min. switching capacity at 3V IEC 60947-5-4	[mA]	—	—	—	1	—	—	—	1
Load Carrying Capacity per UL/CSA									
Rated voltage	AC	[V]	600	600	125	250	600	600	125
Continuous rating	40 °C	[A]	10	10	0.1	2	10	10	0.1
Switching capacity	AC		A600	A 600	—	—	A 600	A 600	—
Rated voltage	DC	[V]	600	600	110	220	250	250	125
Continuous rating	40 °C	[A]	2.5	2.5	0.1	0.1	2.5	2.5	0.1
Switching capacity	DC		Q600	Q 600	—	—	P 600	Q 300	—

Life-Load Curves

3-pole Contactors – Electrical Durability

Figure 26 - Electrical durability for AC-1 utilization category - $U_e \leq 690V$

Switching non-inductive or slightly inductive loads. The breaking current I_C for AC-1 is equal to the rated operational current of the load.

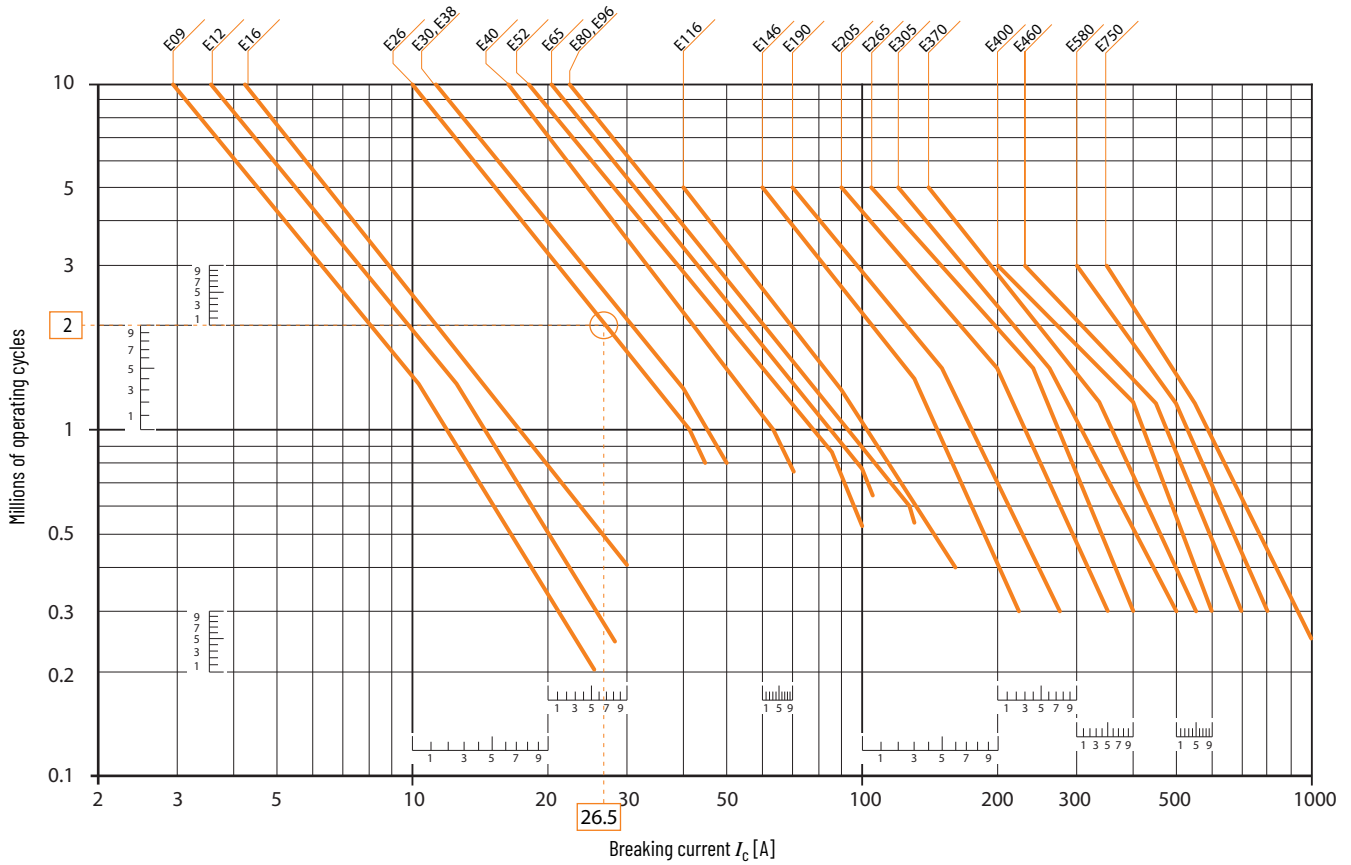

Cat. Nos. 100-E860, -E1060: The electrical durability at the rated current is 50,000 operating cycles.

Figure 27 - Electrical durability for AC-3 utilization category - $U_e \leq 440V$

Switching cage motors: starting and switching off running motors. The breaking current I_c for AC-3 is equal to the rated operational current I_e (I_e = motor full load current).

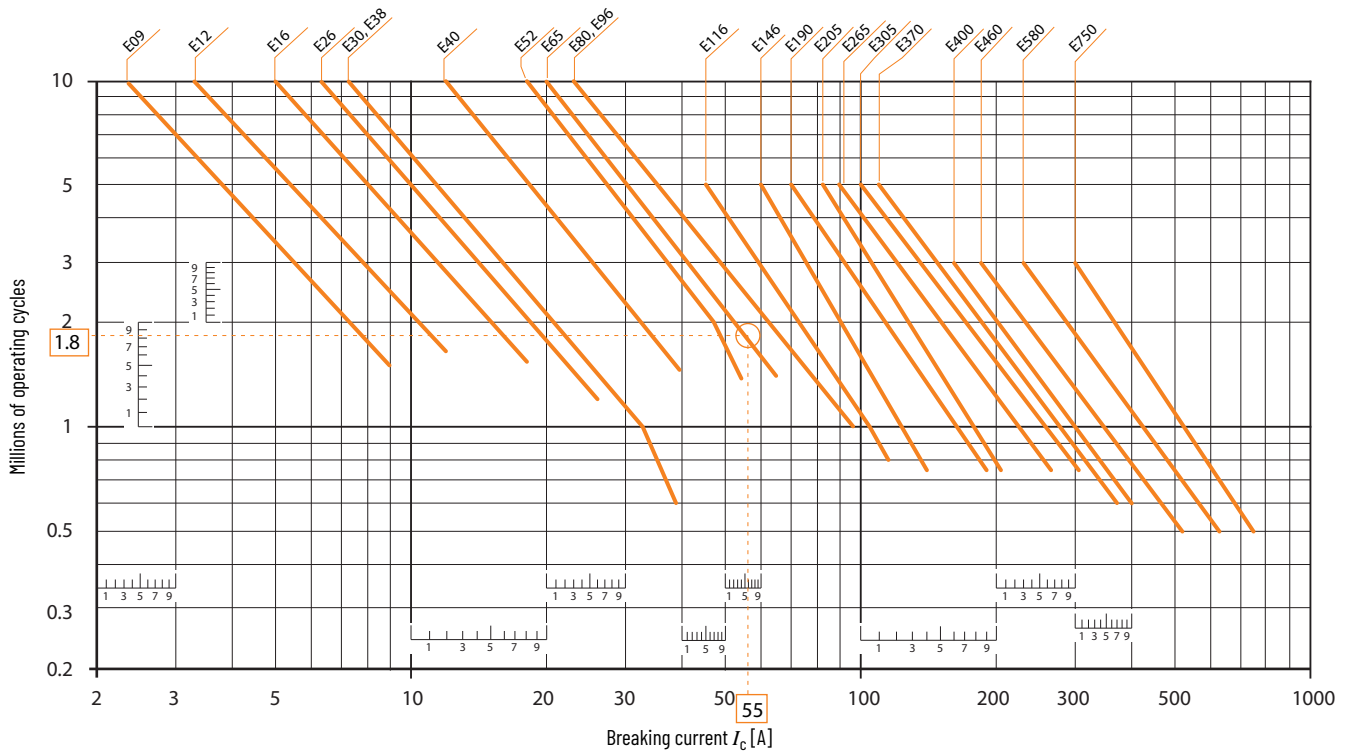

Cat. Nos. 100-E860, -E1060: The electrical durability at the rated current is 50,000 operating cycles.

Figure 28 - Electrical durability for AC-3 utilization category - $440V < U_e \leq 690V$

Switching cage motors: starting and switching off running motors. The breaking current I_c for AC-3 is equal to the rated operational current I_e (I_e = motor full load current).

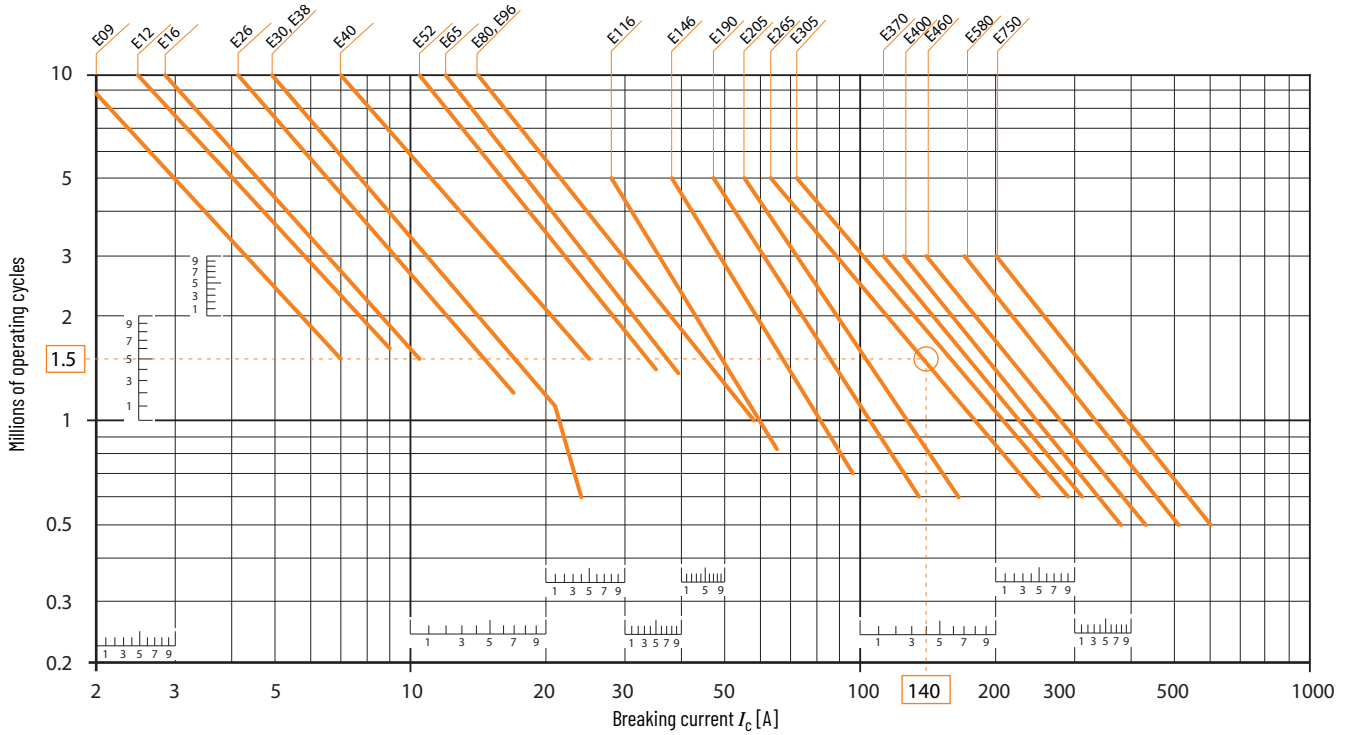

Cat. Nos. 100-E860, -E1060: The electrical durability at the rated current is 50,000 operating cycles.

Figure 29 - Electrical durability for AC-2 or AC-4 utilization category - $U_e \leq 440V$

Switching cage motors: starting, reverse operation and step-by-step operation. The breaking current I_c is equal to $2.5 \times I_e$ for AC-2 and $6 \times I_e$ for AC-4, keeping in mind that I_e is the motor rated operational current (I_e = motor full-load current).

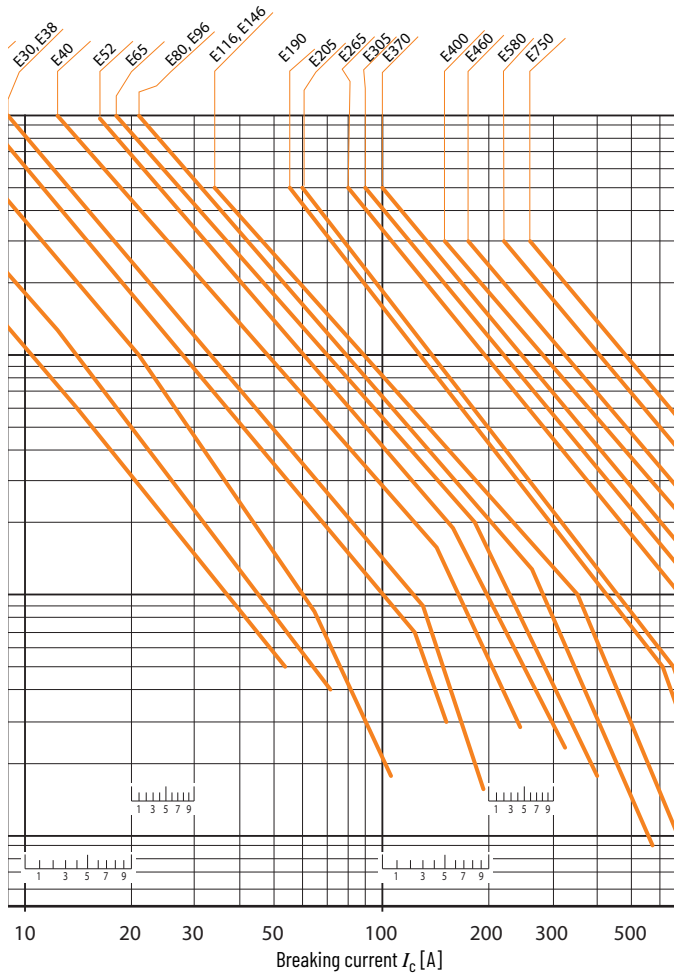
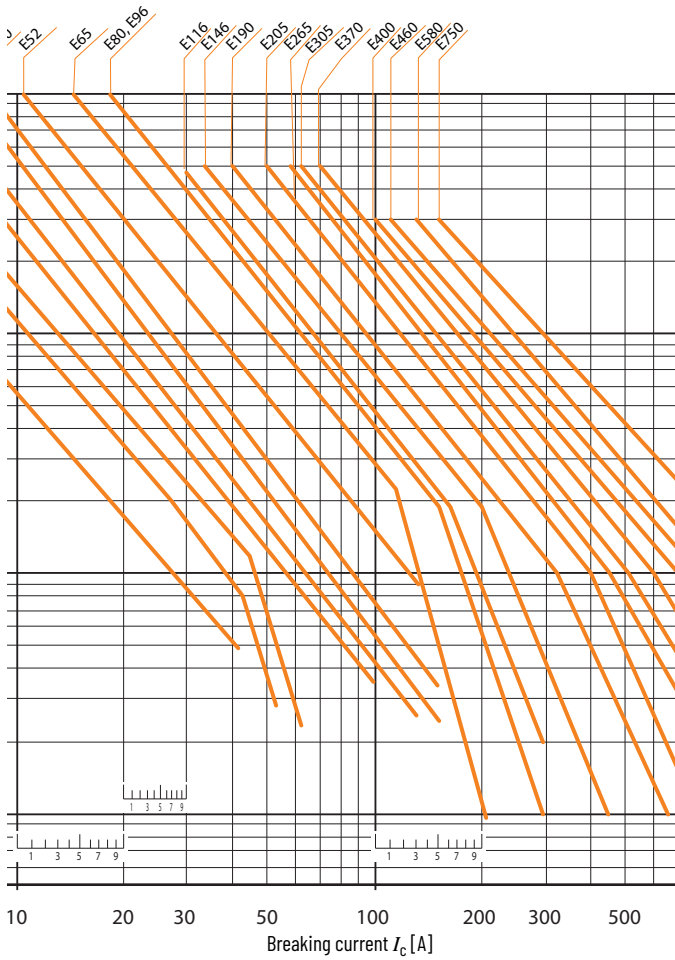

Figure 30 - Electrical durability for AC-2 or AC-4 utilization category - $440V < U_e \leq 690V$

Switching cage motors: starting, reverse operation and step-by-step operation. The breaking current I_c is equal to $2.5 \times I_e$ for AC-2 and $6 \times I_e$ for AC-4, keeping in mind that I_e is the motor rated operational current (I_e = motor full load current).



Auxiliary Contacts for 100-E09...E96 Contactors—Electrical Durability

Figure 31 - Electrical durability for AC-15 utilization category - $U_e \leq 690V$, 40...60 Hz

Switching of resistive or inductive loads according to IEC/EN/UL 60947-5-1

- Making current: $10 \times I_e$ with $\cos \phi - 0.7$
- Breaking current: I_e with $\cos \phi - 0.4$

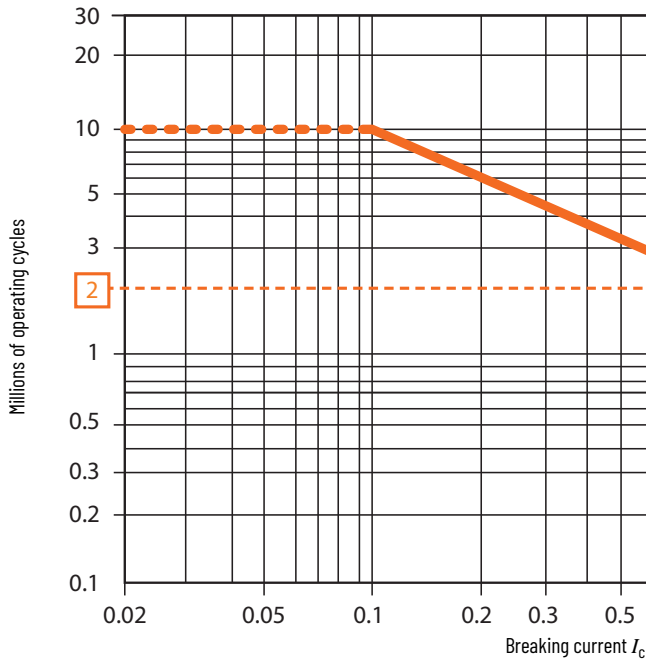
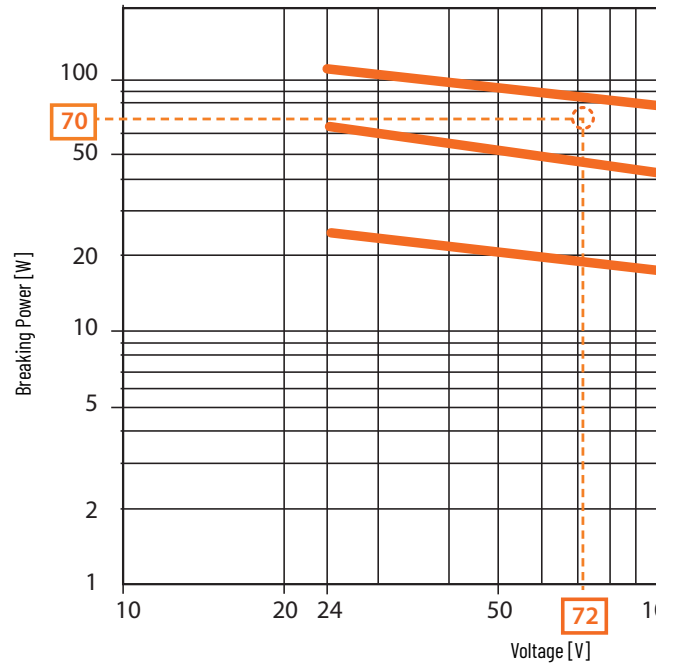

Figure 32 - Electrical durability for DC-13 utilization category - $U_e \leq 250V$

Switching of inductive loads according to IEC/EN/UL 60947-5-1

- Making and breaking current: I_e at U_e



Auxiliary Contacts for 100-E116...E2650 Contactors—Electrical Durability

Figure 33 - Electrical durability for AC-15 utilization category - $U_e \leq 690V, 40...60\text{ Hz}$

Switching of resistive or inductive loads according to IEC/EN/UL 60947-5-1

- Making current: $10 \times I_e$ with $\cos \phi - 0.7$
- Breaking current: I_e with $\cos \phi - 0.4$

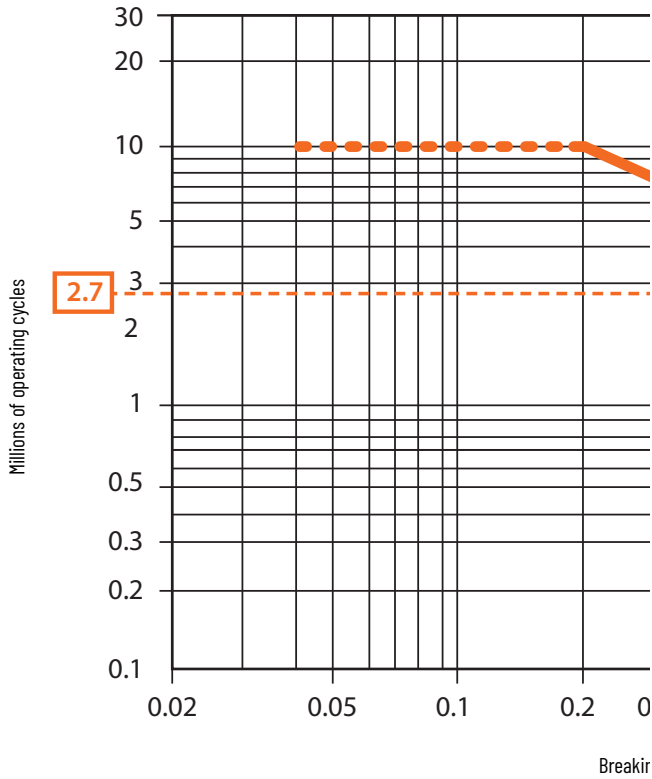

Approximate Dimensions

Dimensions are shown in millimeters (inches). Dimensions are not intended for manufacturing purposes.

Figure 34 - Mounting Position for 100-E09...100-E96 Devices— AC/DC and AC/DC with PLC input

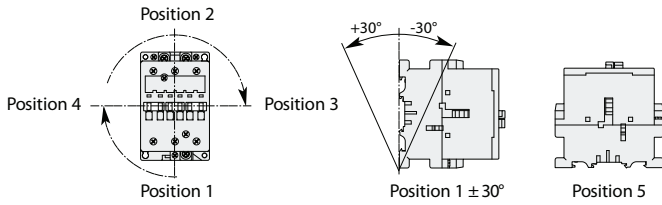
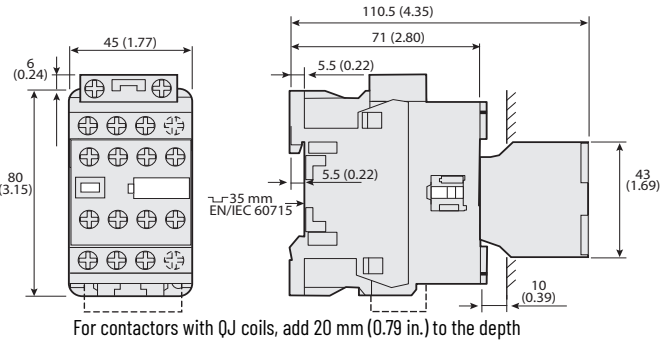

Figure 37 - 100-E09...100-E16 Contactors with Standard Coils and Front-mounted Auxiliary Contact



9...16 A Contactors

Figure 35 - 100-E09...100-E16 Contactors with Standard Coils

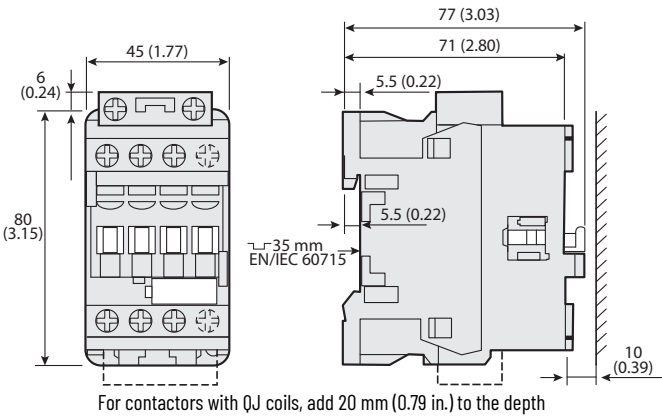

Figure 38 - 100-E09...100-E16 Contactors with Standard Coils and Side-mounted Auxiliary Contact

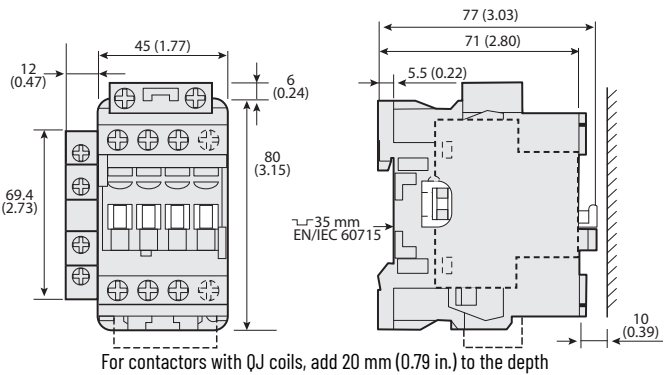

Figure 36 - 100-E09...100-E16 Contactors with Low-consumption Coils

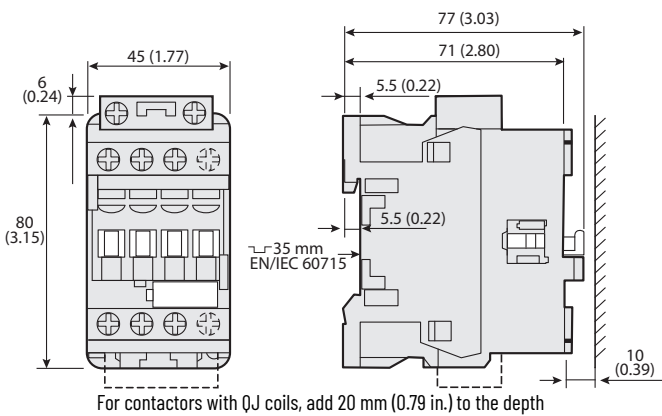

Figure 39 - 100-E09...100-E16 Contactors with Low-consumption Coils and Front-mounted Auxiliary Contact

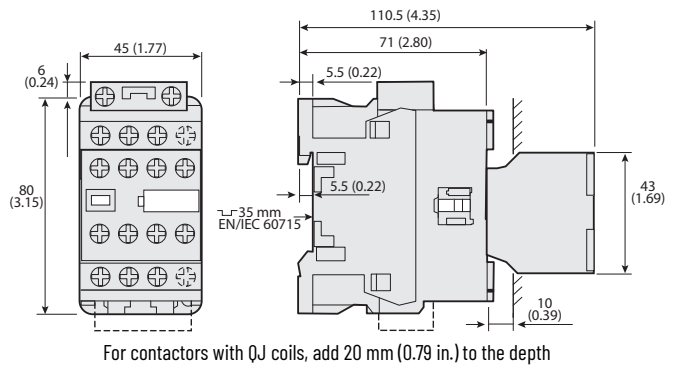

Figure 40 - 100-E09...100-E16 Contactors with Low-consumption Coils and Side-mounted Auxiliary Contact

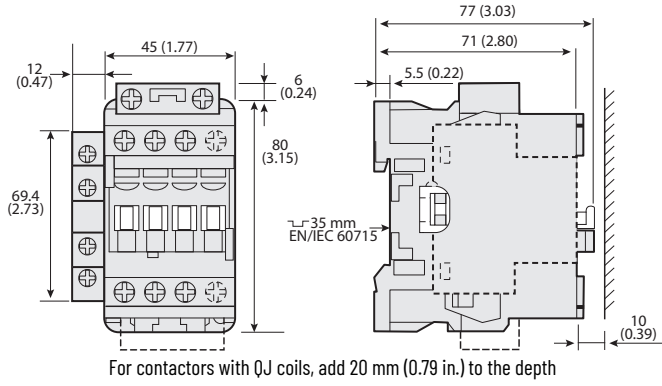

Figure 41 - 104-E09...104-E16 Reversing Contactors with Cat. No. 100-EMCA02 Mechanical and Electrical Interlock

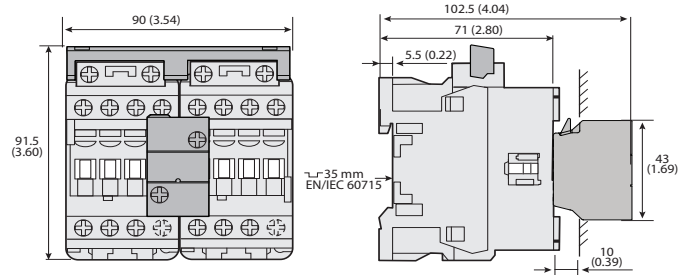
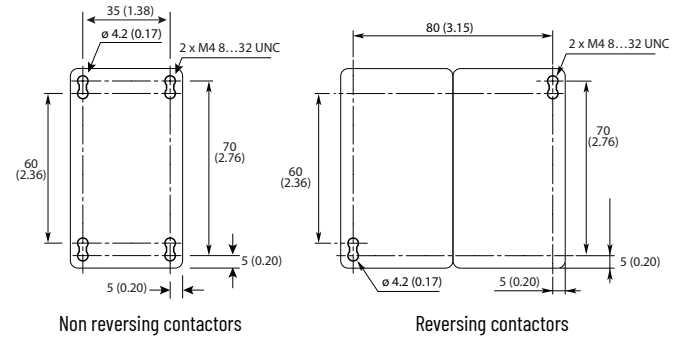

Figure 42 - Drilling Template for 9...16 A Contactors



26...38 A Contactors

Figure 43 - 100-E26...100-E38 3-Pole Contactors with Standard Coils

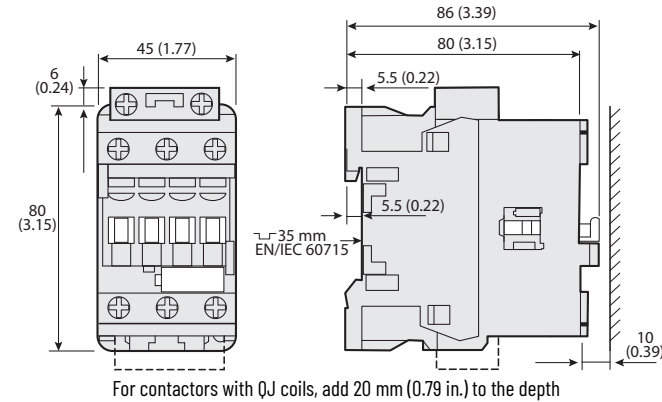

Figure 44 - 100-E26...100-E38 4-Pole Contactors with Standard Coils

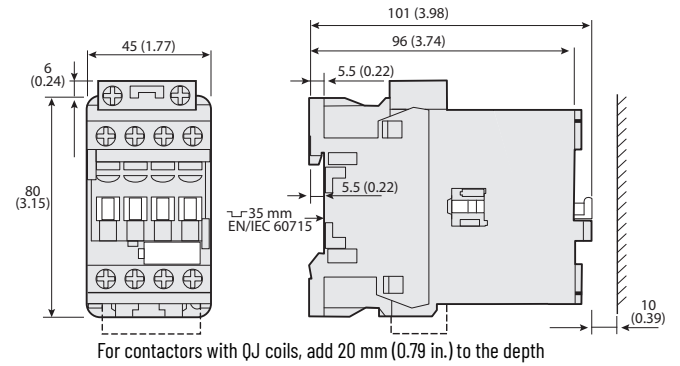

Figure 45 - 100-E26...100-E38 3-Pole Contactors with Low-consumption Coils

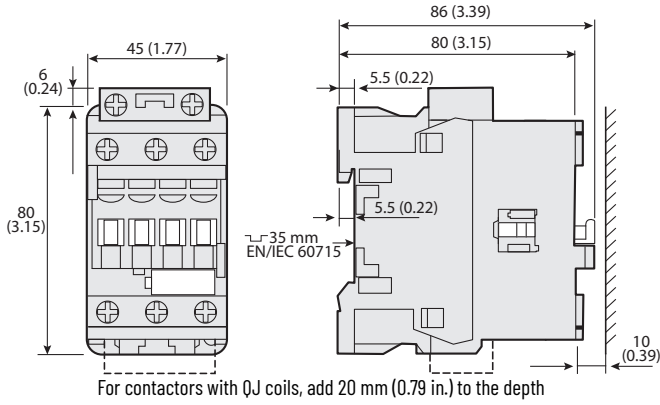

Figure 46 - 100-E26...100-E38 4-Pole Contactors with Low-consumption Coils

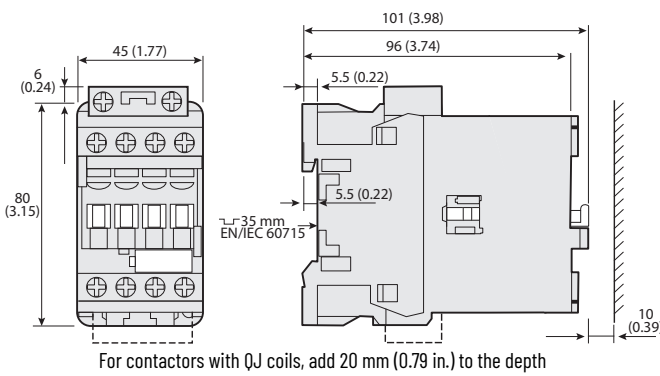

Figure 47 - 100-E26...100-E38 3-Pole Contactors with Standard Coils and Front-mounted Auxiliary Contact

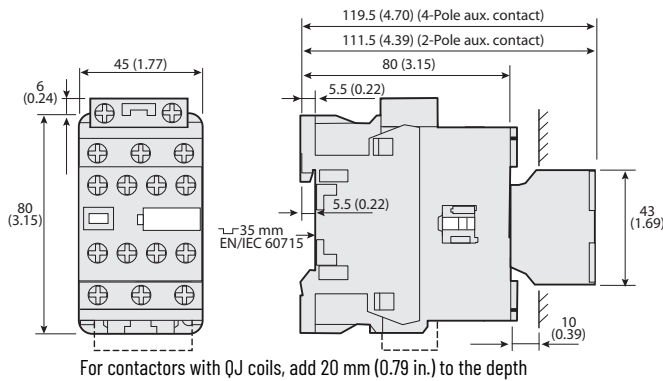

Figure 51 - 100-E26...100-E38 3-Pole Contactors with Low-consumption Coils and Front-mounted Auxiliary Contact

Figure 48 - 100-E26...100-E38 4-Pole Contactors with Standard Coils and Front-mounted Auxiliary Contact

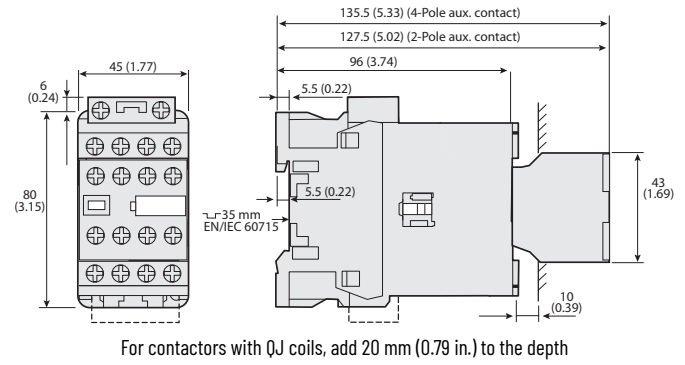

Figure 49 - 100-E26...100-E38 3-Pole Contactors with Standard Coils and Side-mounted Auxiliary Contact

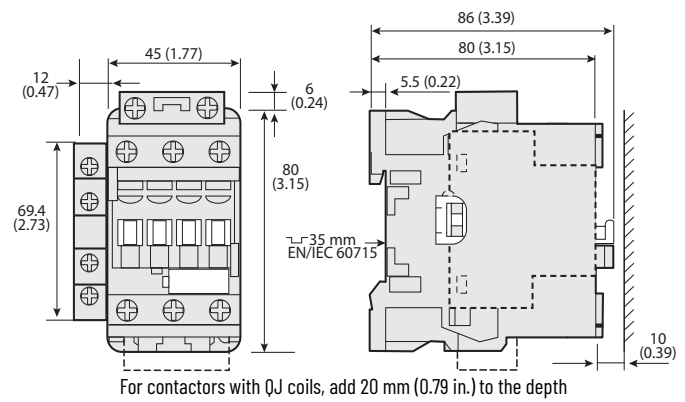

Figure 50 - 100-E26...100-E38 4-Pole Contactors with Standard Coils and Side-mounted Auxiliary Contact

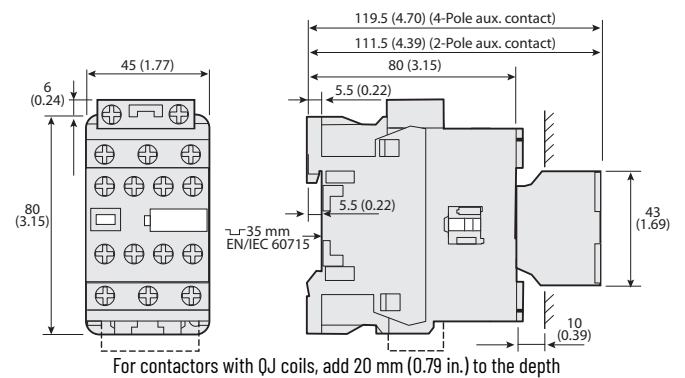
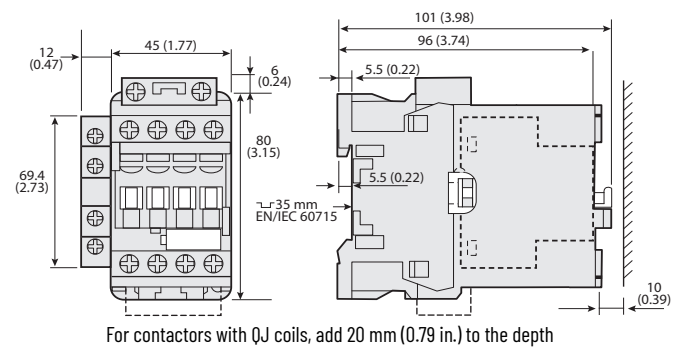

Figure 52 - 100-E26...100-E38 4-Pole Contactors with Low-consumption Coils and Front-mounted Auxiliary Contact

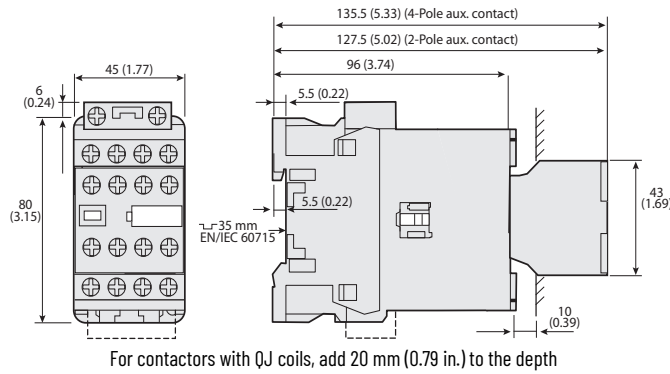

Figure 56 - Drilling Template for 26...38 A Contactors

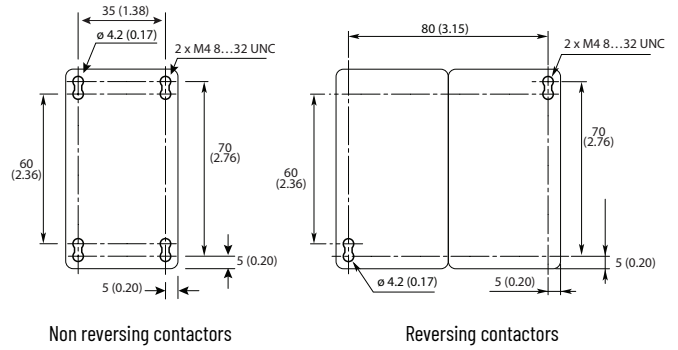

Figure 53 - 100-E26...100-E38 3-Pole Contactors with Low-consumption Coils and Side-mounted Auxiliary Contact

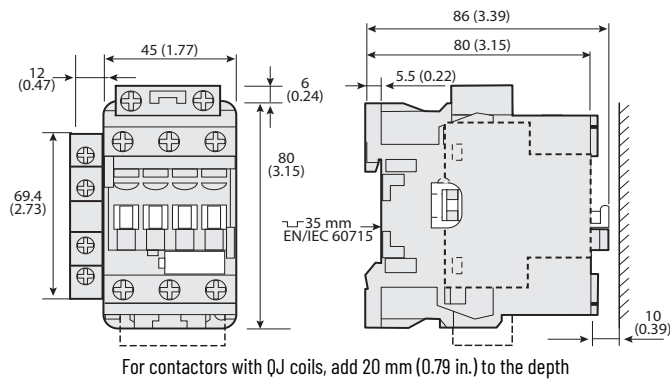

Figure 54 - 100-E26...100-E38 4-Pole Contactors with Low-consumption Coils and Side-mounted Auxiliary Contact

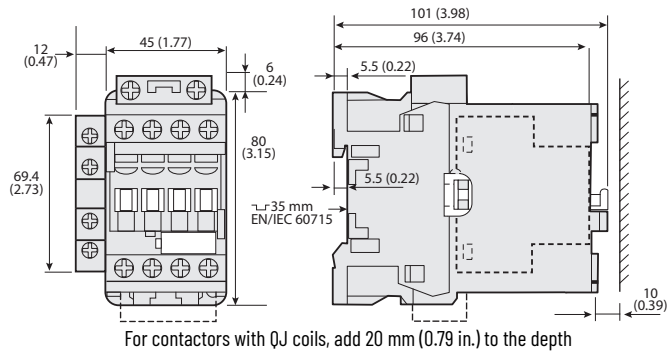
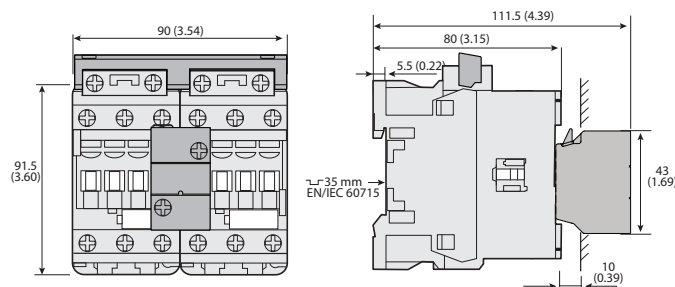

Figure 55 - 104-E26...104-E38 Reversing Contactors with Cat. No. 100-EMCA02 Mechanical and Electrical Interlock



40...65 A Contactors

Figure 57 - 100-E40...100-E65 3-Pole Contactors

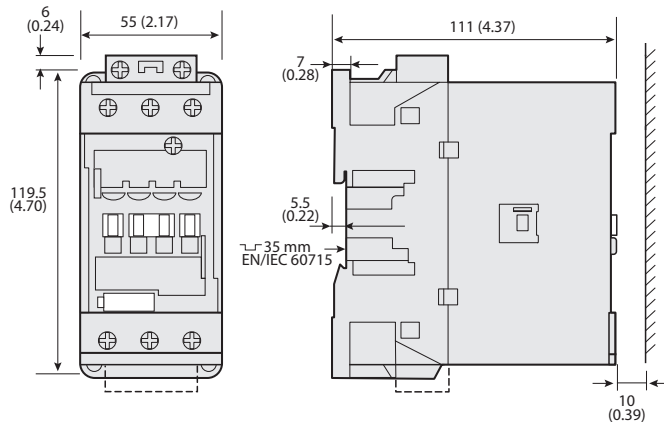

Figure 60 - 104-E40...104-E65 Reversing 3-Pole Contactors

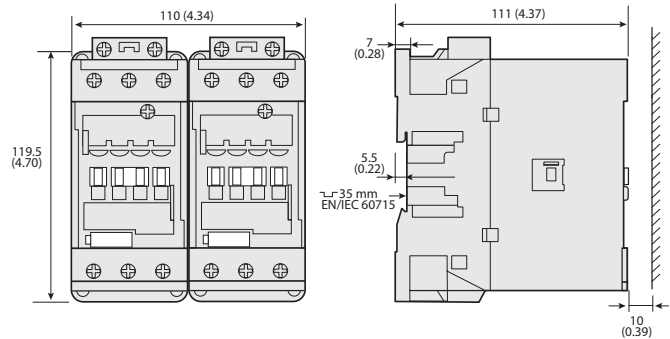

Figure 58 - 100-E40...100-E65 3-Pole Contactors with Front-mounted Auxiliary Contact

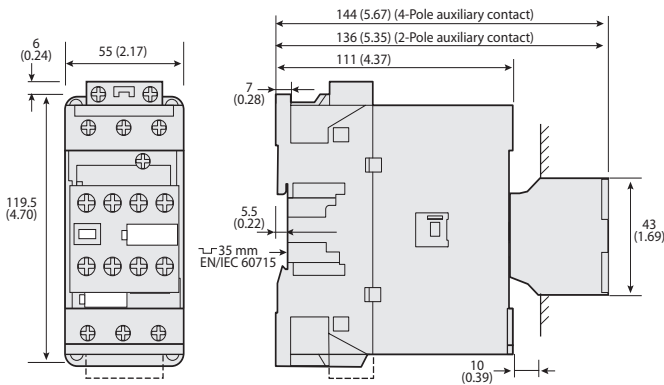

Figure 61 - Drilling Template for 40...65 A 3-Pole Contactors

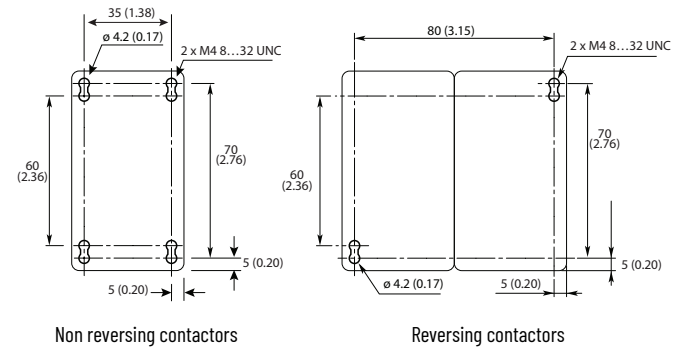

Figure 59 - 100-E40...100-E65 3-Pole Contactors with Side-mounted Auxiliary Contact

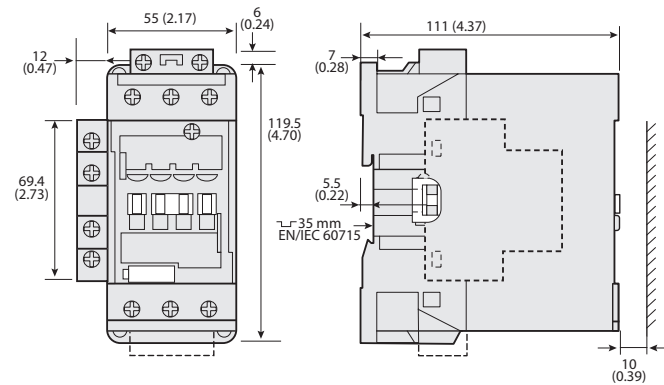

Figure 62 - 100-E40...100-E52 4-Pole Contactors

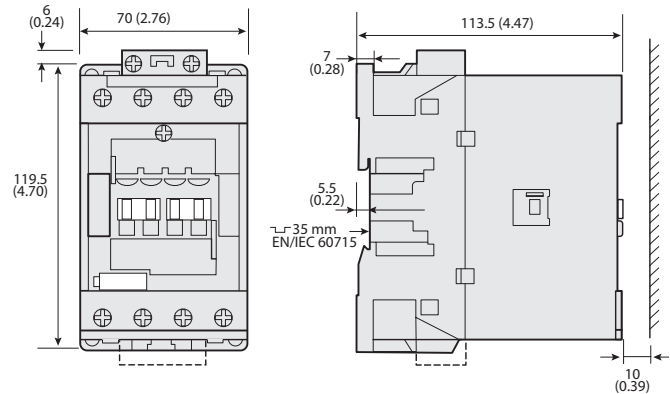

Figure 63 - 100-E40...100-E52 4-Pole Contactors with Front-mounted Auxiliary Contact

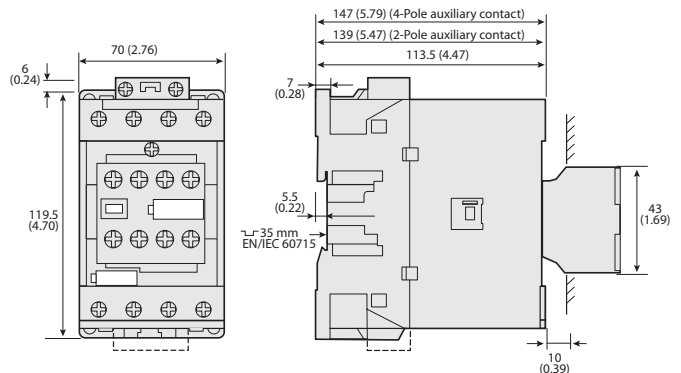

Figure 64 - 100-E40...100-E52 4-Pole Contactors with Side-mounted Auxiliary Contact

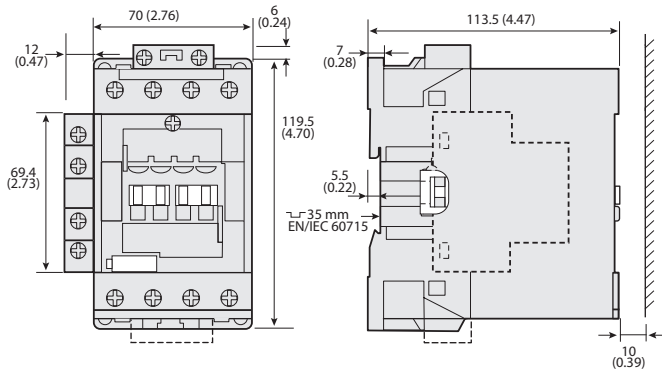
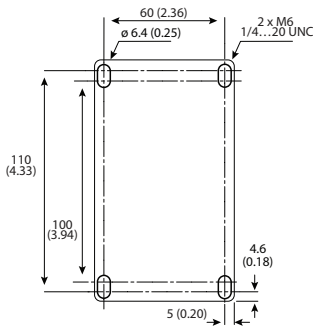

Figure 65 - Drilling Template for 40...52 A 4-Pole Contactors



80...96 A Contactors

Figure 66 - 100-E80...100-E96 3-Pole Contactors

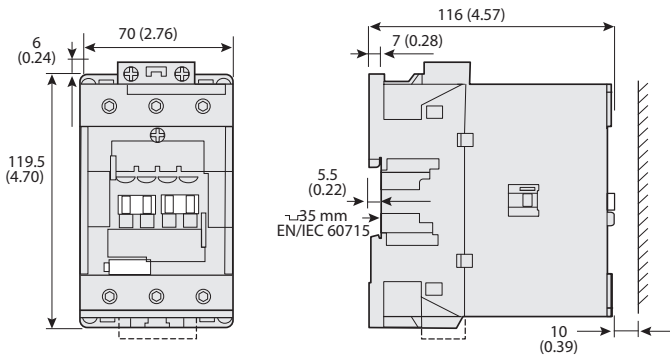

Figure 67 - 100-E80...100-E96 3-Pole Contactors with Front-mounted Auxiliary Contact

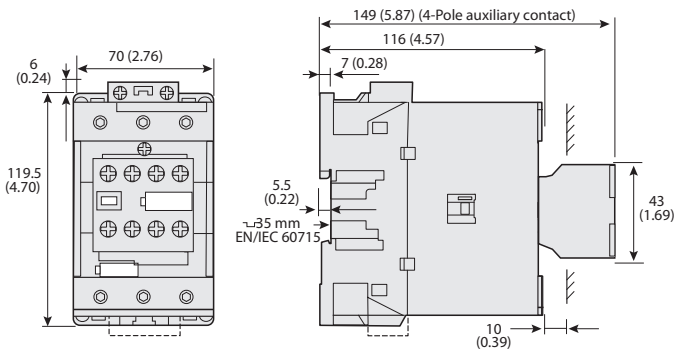

Figure 68 - 100-E80...100-E96 3-Pole Contactors with Side-mounted Auxiliary Contact

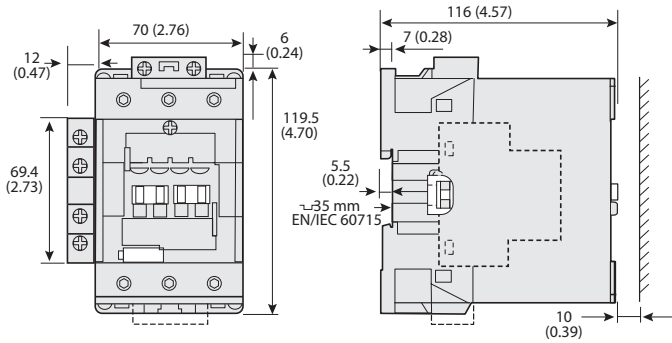

Figure 69 - 104-E80...104-E96 Reversing 3-Pole Contactors

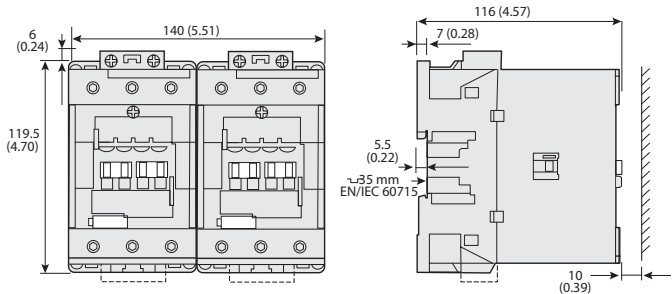

Figure 70 - Drilling Template for 80...96 A 3-Pole Contactors

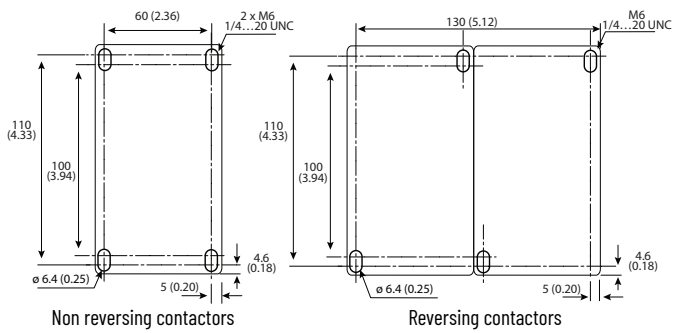

Figure 71 - 100-E80 4-Pole Contactors

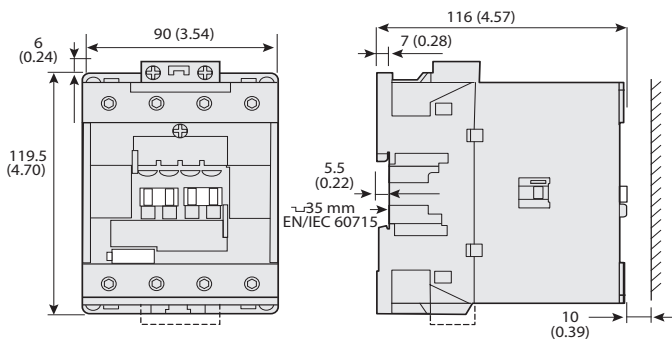

Figure 72 - 100-E80 4-Pole Contactors with Front-mounted Auxiliary Contact

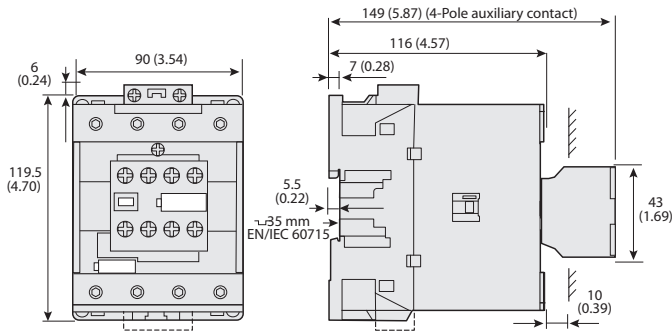

Figure 73 - 100-E80 4-Pole Contactors with Side-mounted Auxiliary Contact

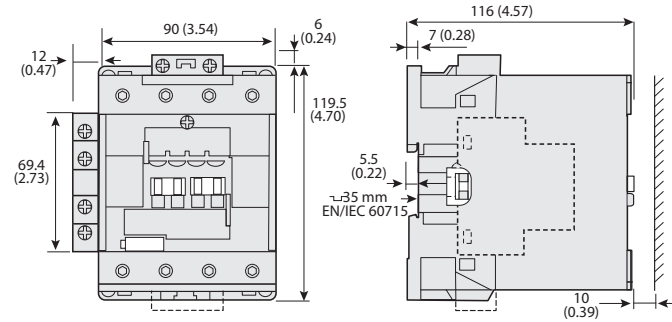
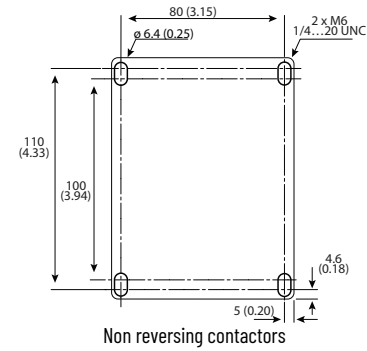

Figure 74 - Drilling Template for 80 A 4-Pole Contactors



116...2650 A Contactors

Figure 75 - Mounting Position for 100-E116...100-E2650 Devices— AC/DC and AC/DC with PLC input

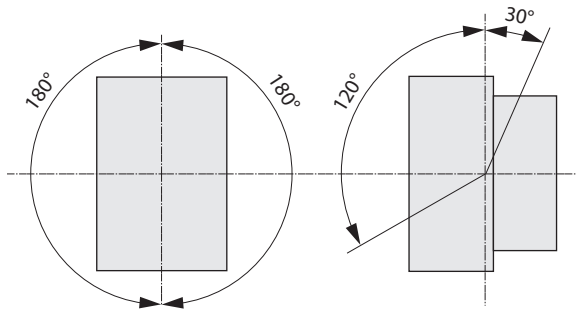

Figure 76 - 100-E116K..., 100-E146K... Contactors

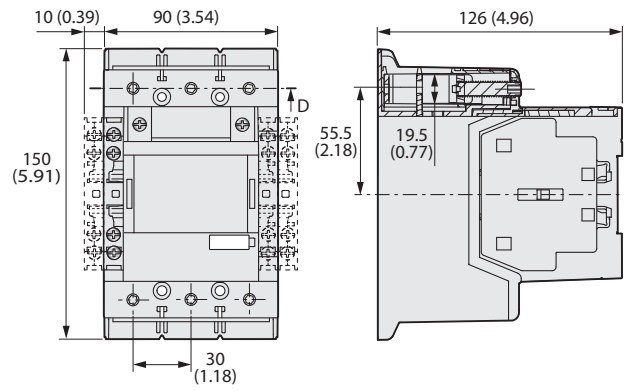

Figure 77 - 100-E116E..., 100-E146E... Contactors with PLC Input

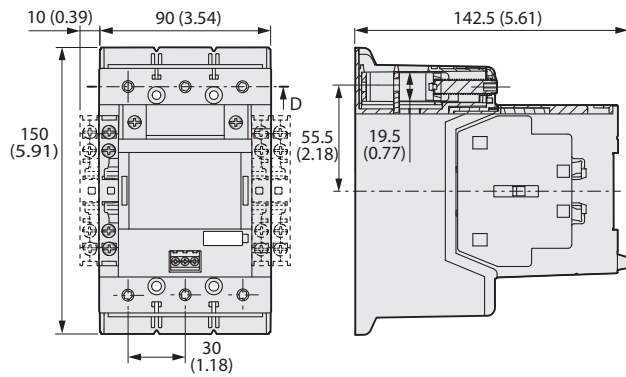

Figure 78 - 104-E116E..., 104-E146E... Reversing Contactors with Cat. No. 100-EM... Mechanical Interlock

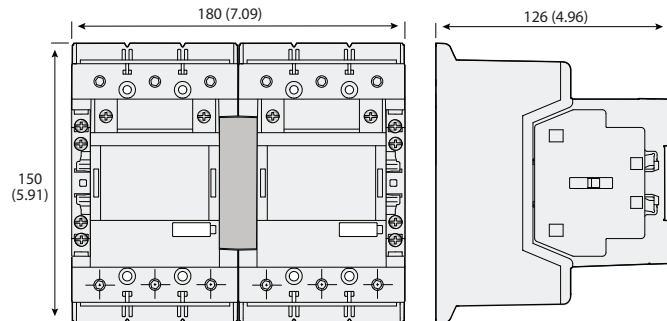

Figure 79 - Drilling Template for 116...146 A 3-Pole Contactors

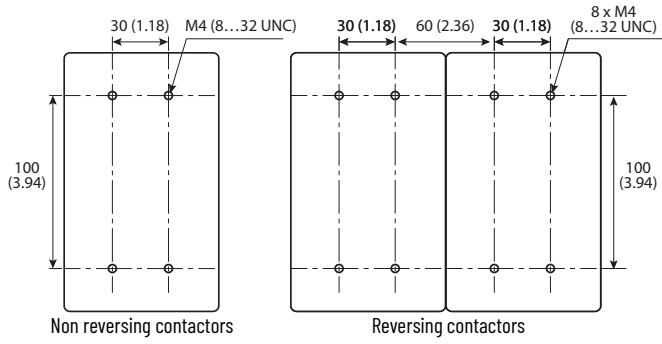

Figure 80 - 100-E190, 100-E205 Contactors

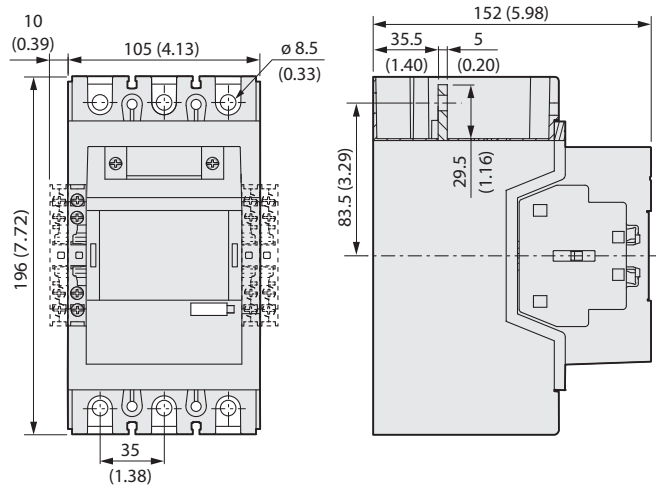

Figure 81 - 100-E190E, 100-E205E Contactors with PLC Input

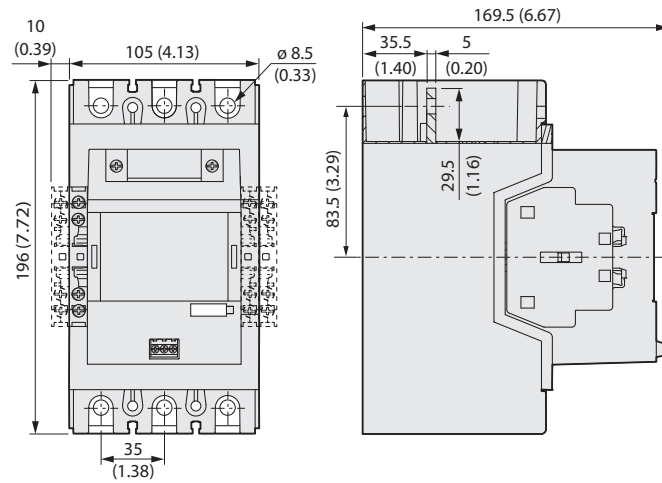

Figure 82 - 104-E190, 104-E205 Reversing Contactors with Cat. No. 100-EM... Mechanical Interlock

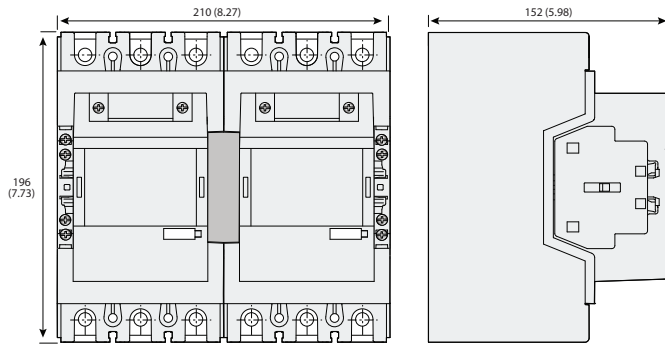

Figure 83 - Drilling Template for 190...205 A 3-Pole Contactors

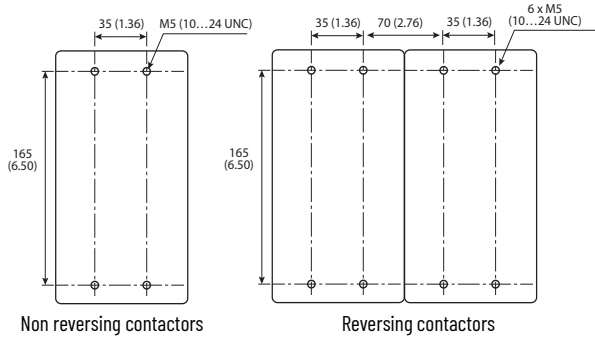

Figure 84 - 100-E265...100-E370 Contactors

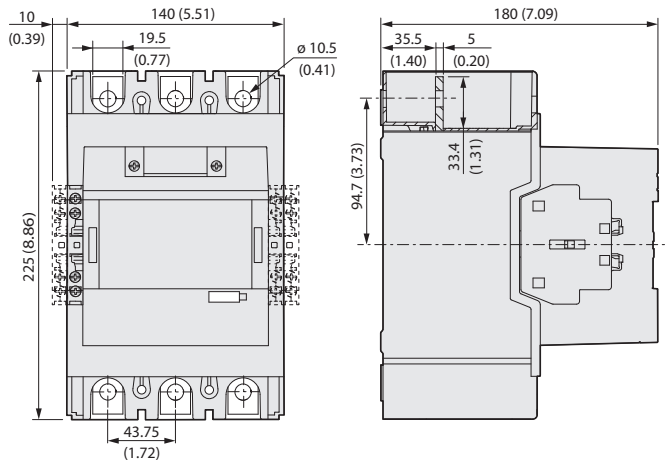

Figure 85 - 100-E265E...100-E370E Contactors with PLC Input

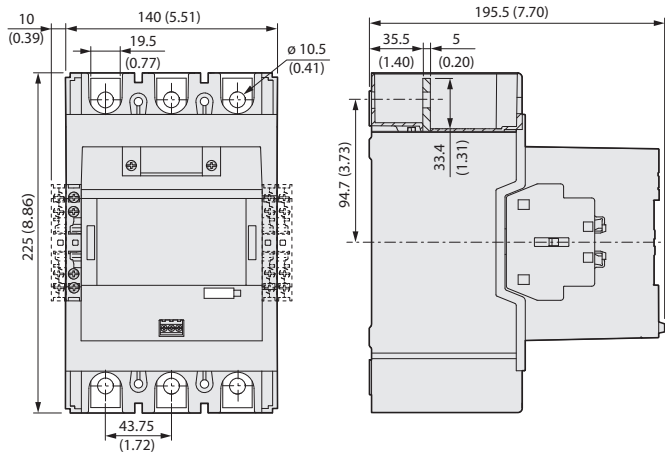

Figure 86 - 104-E265...104-E370 Reversing Contactors with Cat. No. 100-EM... Mechanical Interlock

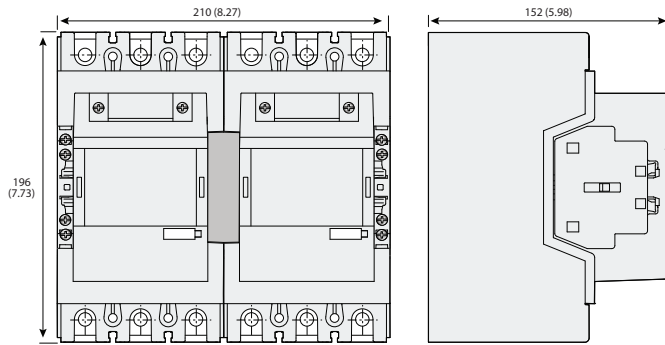

Figure 87 - Drilling Template for 265...370 A 3-Pole Contactors

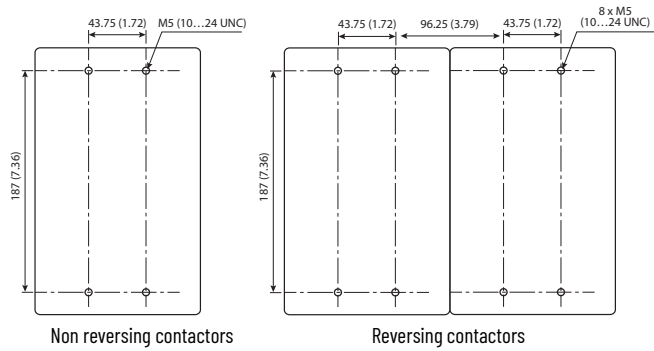

Figure 88 - 100-E400, 100-E460 Contactors with PLC Input

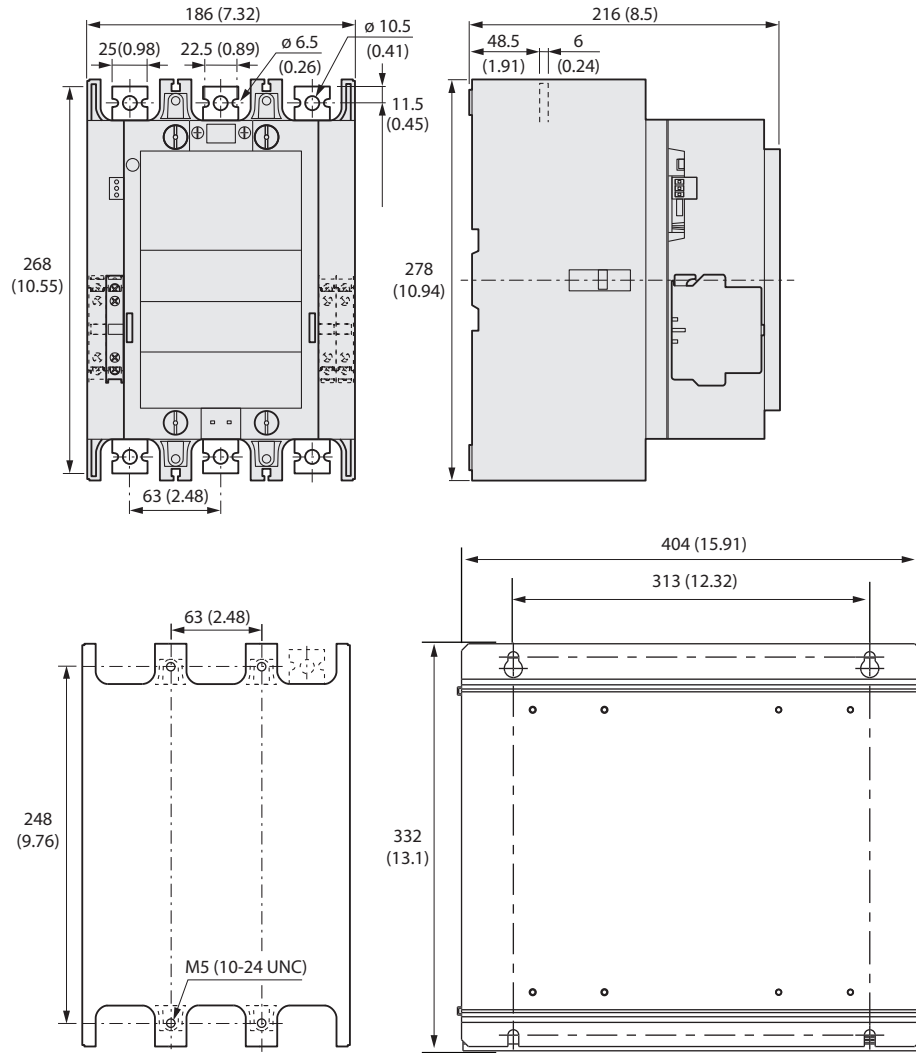

Figure 89 - 100-E580...100-E750 Contactors with PLC Input

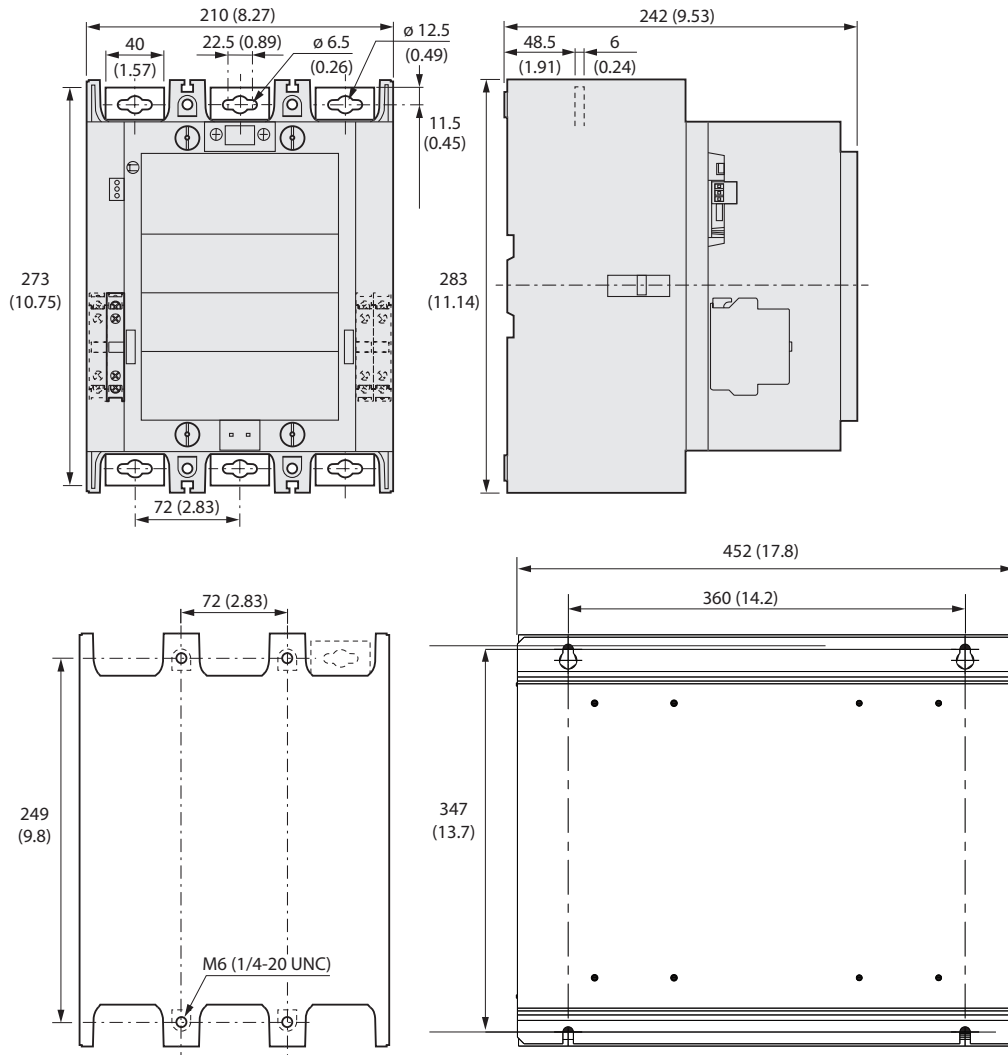

Figure 90 - 100-E1260 Contactors with PLC Input

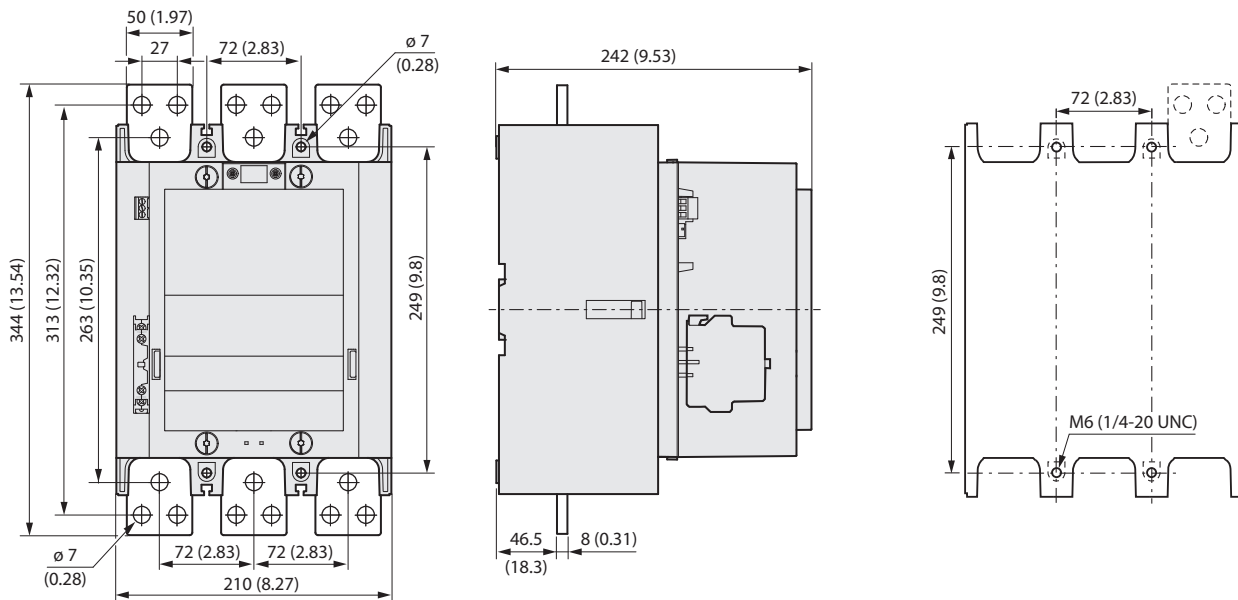
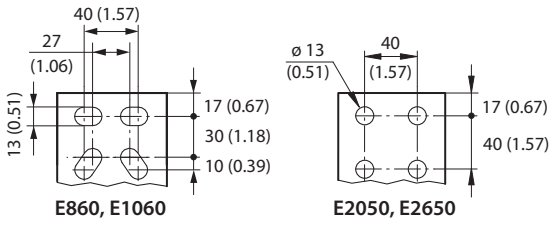
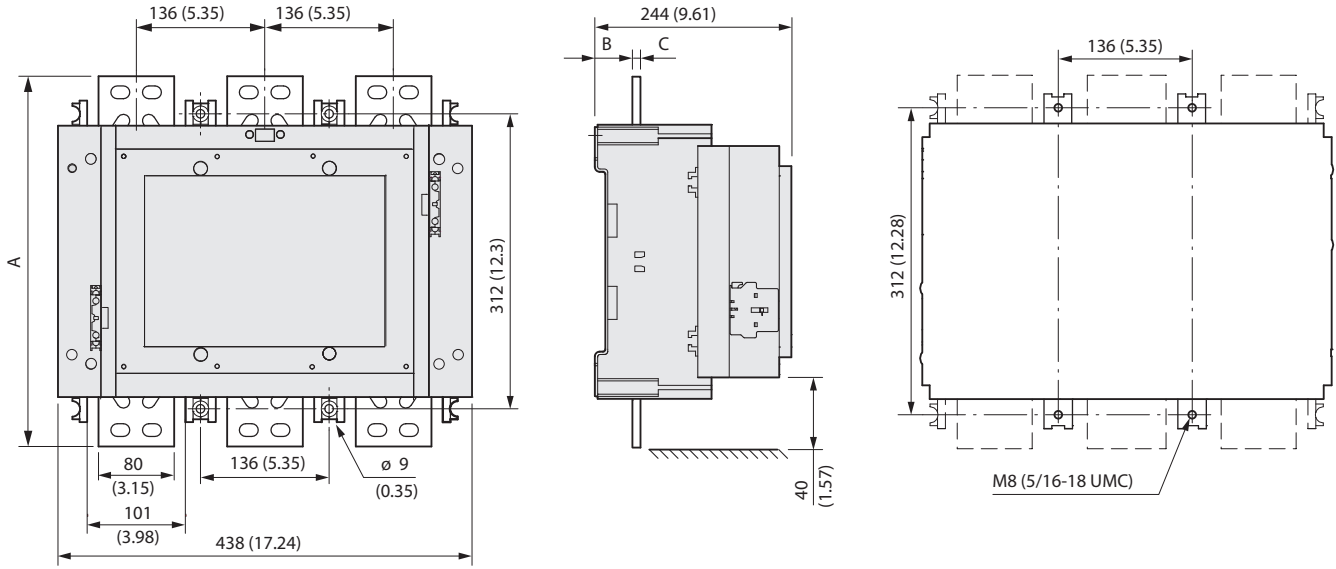

Figure 91 - 100-E860, 100-E1060, 100-E2050, 100-E2650 Contactors with PLC Input



	E860, E1060, E2050	E2650
A	392 (15.43)	422 (16.61)
B	47 (1.85)	53 (2.09)
C	10 (0.39)	25 (0.98)



Additional Resources

These documents contain additional information concerning related products from Rockwell Automation.

Resource	Description
UL Standards Listing for Industrial Control Products, publication CMPNTS-SR002	Assists original equipment manufacturers (OEMs) with construction of panels, to help ensure that they conform to the requirements of Underwriters Laboratories.
American Standards, Configurations, and Ratings: Introduction to Motor Circuit Design, publication IC-AT001	Provides an overview of American motor circuit design based on methods that are outlined in the NEC.
Industrial Components Preventive Maintenance, Enclosures, and Contact Ratings Specifications, publication IC-TD002	Provides a quick reference tool for Allen-Bradley industrial automation controls and assemblies.
Safety Guidelines for the Application, Installation, and Maintenance of Solid-state Control, publication SGI-1.1	Designed to harmonize with NEMA Standards Publication No. ICS 1.1-1987 and provides general guidelines for the application, installation, and maintenance of solid-state control in the form of individual devices or packaged assemblies incorporating solid-state components.
Industrial Automation Wiring and Grounding Guidelines, publication 1770-4.1	Provides general guidelines for installing a Rockwell Automation industrial system.
ProposalWorks™ configuration software, rok.auto/systemtools	Helps configure complete, valid catalog numbers and build complete quotes based on detailed product information.
Rockwell Automation Global SCCR tool, rok.auto/sccr	Provides coordinated high-fault branch circuit solutions for motor starters, soft starters, and component drives.
Product Certifications website, rok.auto/certifications	Provides declarations of conformity, certificates, and other certification details.

You can view or download publications at rok.auto/literature.

Rockwell Automation Support

Use these resources to access support information.

Technical Support Center	Find help with how-to videos, FAQs, chat, user forums, Knowledgebase, and product notification updates.	rok.auto/support
Local Technical Support Phone Numbers	Locate the telephone number for your country.	rok.auto/phonesupport
Technical Documentation Center	Quickly access and download technical specifications, installation instructions, and user manuals.	rok.auto/techdocs
Literature Library	Find installation instructions, manuals, brochures, and technical data publications.	rok.auto/literature
Product Compatibility and Download Center (PCDC)	Download firmware, associated files (such as AOP, EDS, and DTM), and access product release notes.	rok.auto/pcdc





Documentation Feedback

Your comments help us serve your documentation needs better. If you have any suggestions on how to improve our content, complete the form at rok.auto/docfeedback.

Allen-Bradley, expanding human possibility, ProposalWorks, and Rockwell Automation are trademarks of Rockwell Automation, Inc. Trademarks not belonging to Rockwell Automation are property of their respective companies.

Rockwell Automation maintains current product environmental compliance information on its website at rok.auto/pec.

Rockwell Otomasyon Ticaret A.Ş. Kar Plaza İş Merkezi E Blok Kat:6 34752, İçerenköy, İstanbul, Tel: +90 (216) 5698400 EEE Yönetmeliğine Uygundur

Connect with us.    

rockwellautomation.com ————— expanding **human possibility**[®]

AMERICAS: Rockwell Automation, 1201 South Second Street, Milwaukee, WI 53204-2496 USA, Tel: (1) 414.382.2000, Fax: (1) 414.382.4444

EUROPE/MIDDLE EAST/AFRICA: Rockwell Automation NV, Pegasus Park, De Kleetlaan 12a, 1831 Diegem, Belgium, Tel: (32) 2 663 0600, Fax: (32) 2 663 0640

ASIA PACIFIC: Rockwell Automation, Level 14, Core F, Cyberport 3, 100 Cyberport Road, Hong Kong, Tel: (852) 2887 4788, Fax: (852) 2508 1846

UNITED KINGDOM: Rockwell Automation Ltd. Pitfield, Kiln Farm Milton Keynes, MK11 3DR, United Kingdom, Tel: (44)(1908) 838-800, Fax: (44)(1908) 261-917

Publication 100-TD013L-EN-P - June 2023

Supersedes Publication 100-TD013K-EN-P - June 2022

Copyright © 2023 Rockwell Automation, Inc. All rights reserved. Printed in the U.S.A.